

# Railway Earthing

CADWELD® – Earthing Bonds and Earthing Connections for Electrical Railways

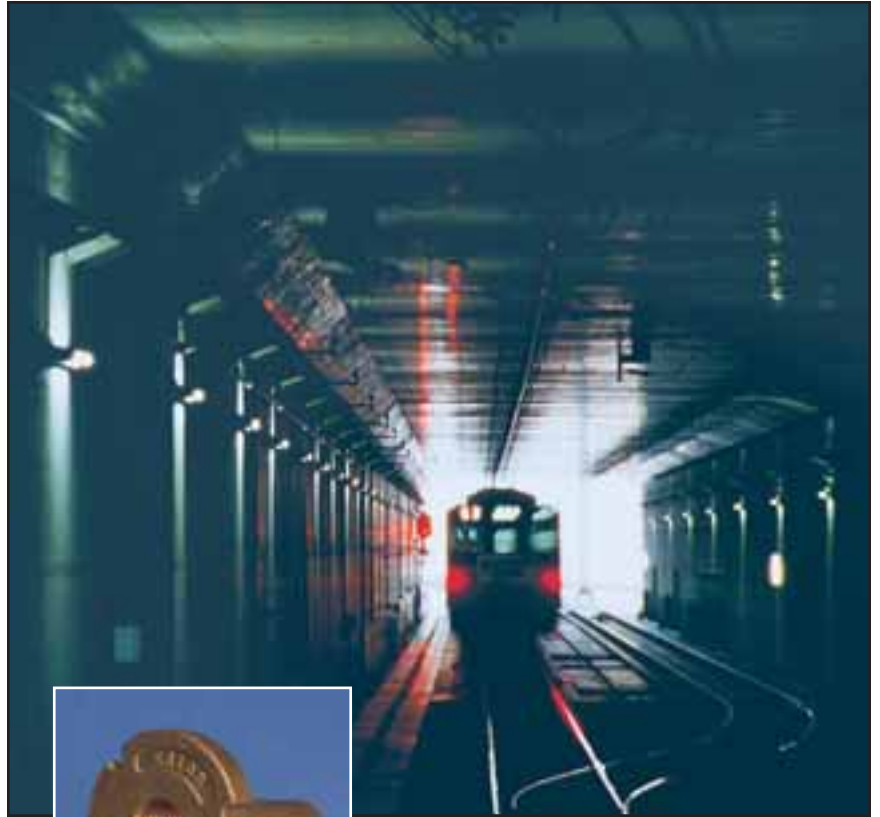

**ERICO**®

# Introduction

## Earthing Bonds

ERICO manufactures prefabricated earthing bonds to customized specifications. These bonds are made from galvanized or copper cables. The CADWELD® exothermic connection process is employed to attach an earth plate on one end of the bond and a steel connection plate on the other end. The steel connection plate is welded on site to reinforcing bars, flat steel strip or steel beams, whatever is specified as a conductor.

Low resistance to corrosion makes a permanently welded CADWELD bond the best solution for connections inside concrete structures. The property of low resistance is important for earthing and cathodic protection of reinforcing bars and steel beams in bridges and tunnels. However, other acceptable methods of connections are to combine a CADWELD connection and a mechanically crimped connection, or a mechanically crimped connection on both ends of the earthing bond.

An equipotential bond between all current carrying elements in a structure and earth is required for personnel safety in case of catenary failure.

A cathodic protection system prevents damage to steel work due to corrosion and reduces expensive maintenance.



FDB-16

## How To

The connection is made to reinforcing bars prior to pouring the concrete. The steel connection plate is connected to the steel reinforcing bars by welding in place. The earthing plate is temporarily bolted or nailed to the internal surface of the formwork. When the formwork is removed, only the contact surface of the earthing plate appears. The earthing plate is equipped with a threaded hole in order to connect a standard cable lug of an earthing conductor. When the reinforcing bars are discontinued (for example expansion joints), earthing bonds connect them electrically by the use of prefabricated jumpers, made from an insulated flexible cable equipped with a standard cable lug on each end.

## Benefits

- Earthing Bonds (CADWELD - CADWELD) can be custom manufactured according to your specifications
- Earthing Bonds are available in 500 and 1000 mm lengths, and in 70 and 95 mm<sup>2</sup> diameters
- ERICO offers three styles of construction:
  1. CADWELD - CADWELD Earthing Bond
  2. CADWELD - Mechanically Crimped Earthing Bond, earthing plate welded with CADWELD, steel plate mechanically crimped
  3. Crimped - Crimped Earthing Bond, earth plate and steel plate both mechanically crimped
- Increased resistance to corrosion with the use of the earthing bonds
- Reduces expensive maintenance

### WARNING

ERICO products shall be installed and used only as indicated in ERICO's product instruction sheets and training materials. Instruction sheets are available at [www.erico.com](http://www.erico.com) and from your ERICO customer service representative. Improper installation, misuse, misapplication or other failure to completely follow ERICO's instructions and warnings may cause product malfunction, property damage, serious bodily injury and death.

### WARRANTY

ERICO products are warranted to be free from defects in material and workmanship at the time of shipment. NO OTHER WARRANTY, WHETHER EXPRESS OR IMPLIED (INCLUDING ANY WARRANTY OF MERCHANTABILITY OR FITNESS FOR A PARTICULAR PURPOSE), SHALL EXIST IN CONNECTION WITH THE SALE OR USE OF ANY ERICO PRODUCTS. Claims for errors, shortages, defects or nonconformities ascertainable upon inspection must be made in writing within 5 days after Buyer's receipt of products. All other claims must be made in writing to ERICO within 6 months from the date of shipment or transport. Products claimed to be nonconforming or defective must, upon ERICO's prior written approval in accordance with its standard terms and procedures governing returns, promptly be returned to ERICO for inspection. Claims not made as provided above and within the applicable time period will be barred. ERICO shall in no event be responsible if the products have not been stored or used in accordance with its specifications and recommended procedures. ERICO will, at its option, either repair or replace nonconforming or defective products for which it is responsible or return the purchase price to the Buyer. THE FOREGOING STATES BUYER'S EXCLUSIVE REMEDY FOR ANY BREACH OF ERICO WARRANTY AND FOR ANY CLAIM, WHETHER SOUNDING IN CONTRACT, TORT OR NEGLIGENCE, FOR LOSS OR INJURY CAUSED BY THE SALE OR USE OF ANY PRODUCT.

### LIMITATION OF LIABILITY

ERICO excludes all liability except such liability that is directly attributable to the willful or gross negligence of ERICO's employees. Should ERICO be held liable its liability shall in no event exceed the total purchase price under the contract. ERICO SHALL IN NO EVENT BE RESPONSIBLE FOR ANY LOSS OF BUSINESS OR PROFITS, DOWNTIME OR DELAY, LABOR, REPAIR OR MATERIAL COSTS OR ANY SIMILAR OR DISSIMILAR CONSEQUENTIAL LOSS OR DAMAGE INCURRED BY BUYER.

# 1. Assembly Instructions

## 1.1 Connection with the casing

Earthing plates DB-16 can be fastened to the formwork as shown in the following. It has to be ensured that the earthing plate and formwork are connected as closely together as possible. This is achieved by pressing the connection surface of the earthing plate plane-parallel onto the formwork.

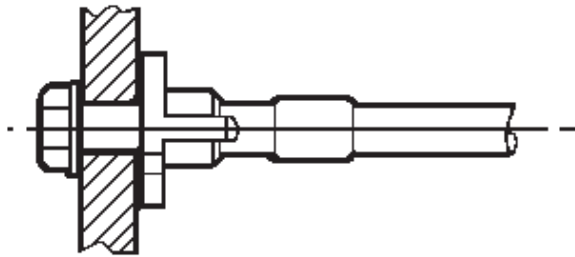

- 1.1.1** The formwork is drilled through and the earthing plate is pulled tightly against the formwork with a bolt M16. Remove this bolt before removing the formwork.

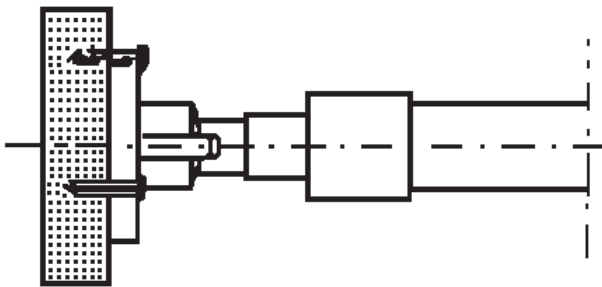

- 1.1.2** Connect the earthing plate to the back of the formwork with nails using the three indents. After removing the formwork, cut off the nail spikes which are sticking out.

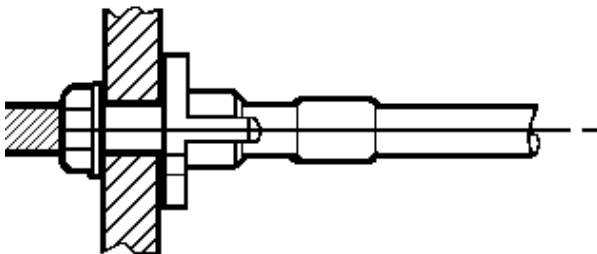

- 1.1.3** For an easy assembly, it is recommended to use a threaded rod with a nut and, depending on the formwork material, with a washer. At first, fasten the threaded rod by hand to the earthing plate, then attach the assembly to the formwork.

## 1.2. Connection with the reinforcement

The electrically connected conducting rods of the reinforcement, designated as earthing conductor, should have a minimum diameter of 16 mm. The flat steel plates are connected to these rods by arc welding. To avoid reduction of the cross sectional area, the tracing dimension of the welded seam must be at least 4 mm.

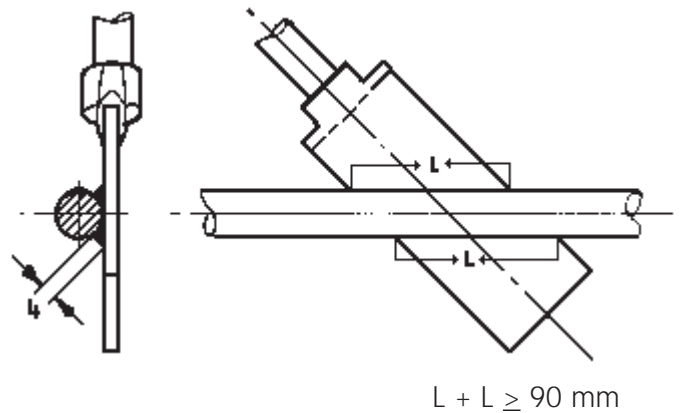

$$L + L \geq 90 \text{ mm}$$

## 2. Summary of Types – Information

The following diagrams show a selection of the most common types. The code of each type is given on the bottom right hand side.

### Linear design, flexible

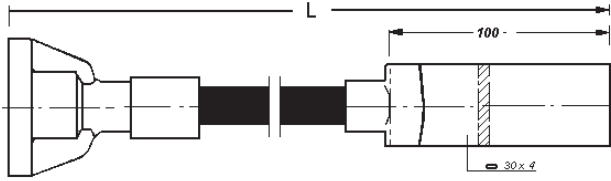

FDBS-16  
FDBC-16  
FDB-16

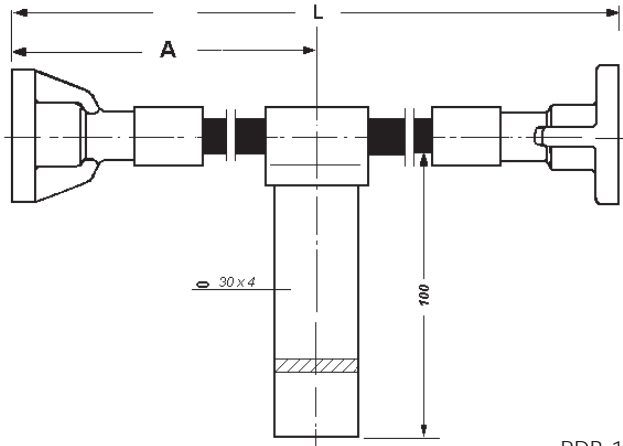

RDB-16

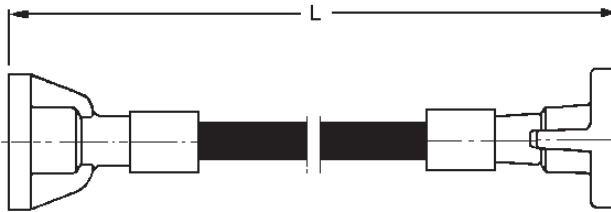

SDB-16

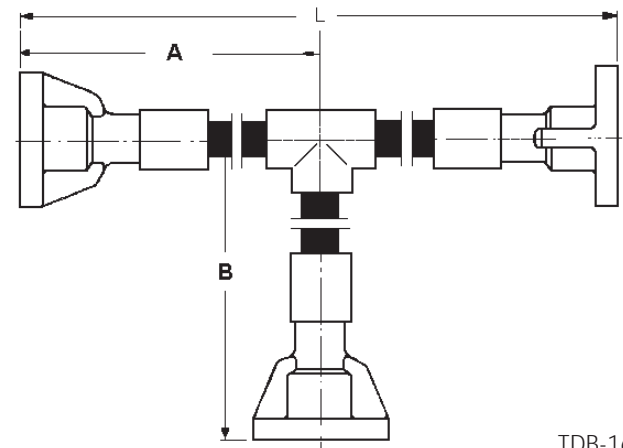

TDB-16

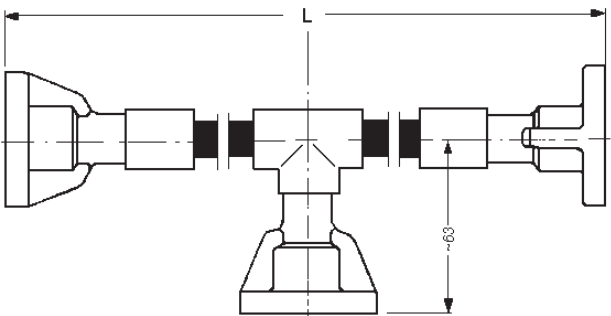

ADB-16

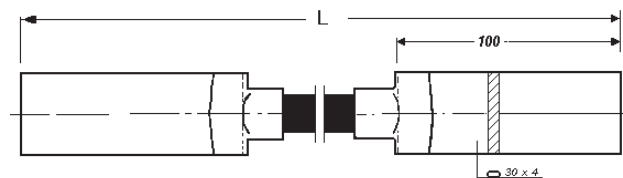

FDB-F

# Right angular design, flexible type WDB-16



WDB-16 Design 1

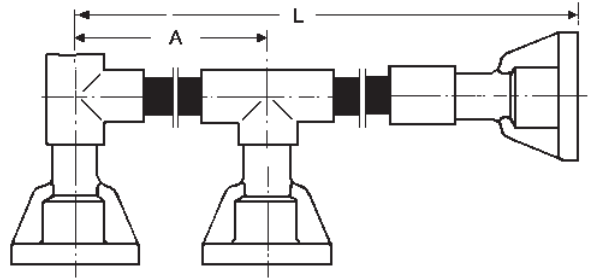

WDB-16 Design 5

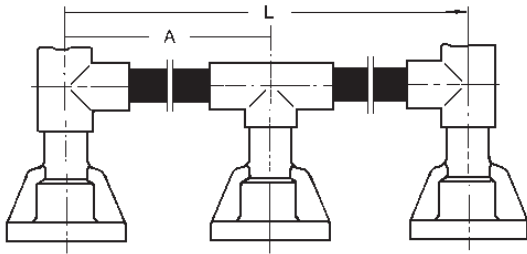

WDB-16 Design 2

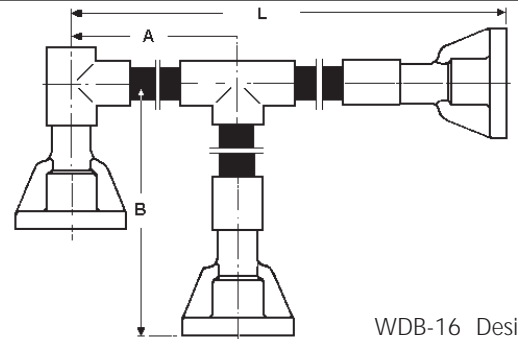

WDB-16 Design 6

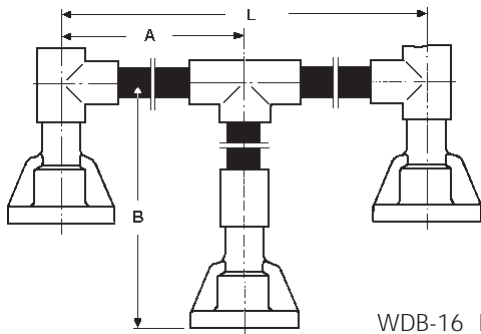

WDB-16 Design 3

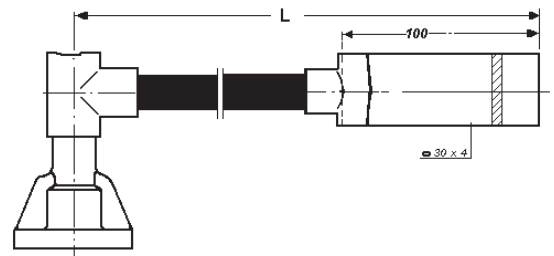

WDB-16 Design 7

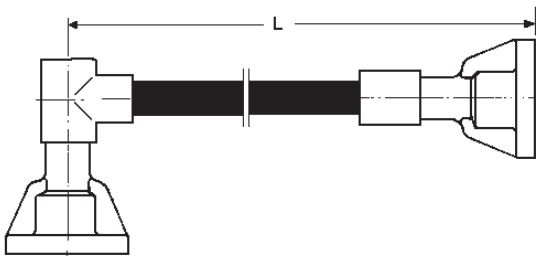

WDB-16 Design 4

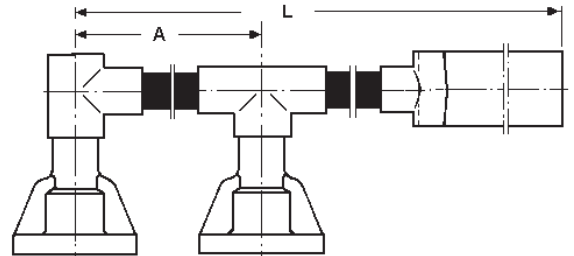

WDB-16 Design 8

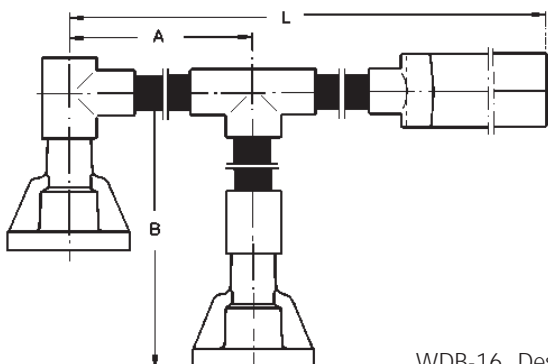

WDB-16 Design 8



WDB-16

## 2.1 Design with solid conductor

The KDB 16 type is to be used on such concrete structures where flexible connections are not necessary (e.g. sound protection walls etc.). The standard length of the steel band is 400 mm. If required, other lengths can also be supplied.

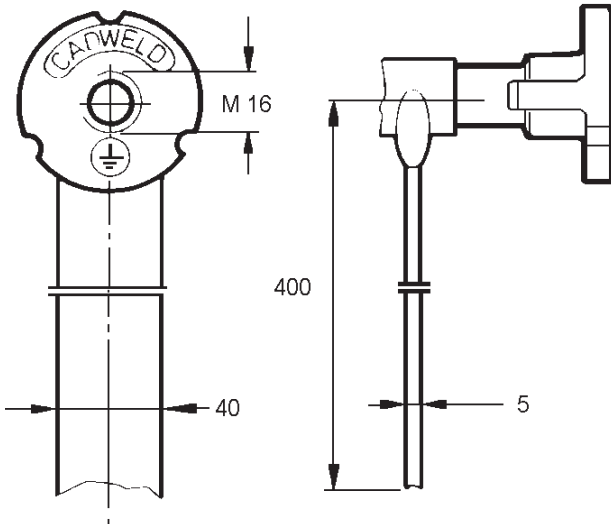

Design with flat steel band KDB-16



FDBC-16

## 2.2 Standardized types

### FDBC

This solid copper earthing point has a hollow core for cable insertion to factory-provide a crimped connection according to DIN VDE 0220 part 2. The copper plated steel welding plate is as well a crimped connection to the cable. This type of Earthing Bond is only available with straight designs.



### FDBS

The FDBS is a combination of a well-known CADWELD welded connection and the crimped cable connection technique. The solid deep-drawn copper earthing point is welded to the copper cable in the factory by means of a CADWELD welded electrical connection. The copper plated steel welding plate is a crimped connection to the copper cable.







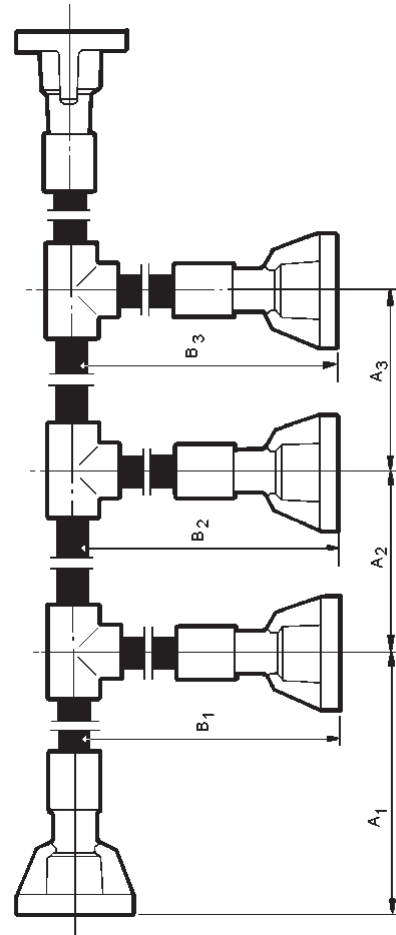

## 2.3 Special designs

With a few structures, (e.g. viaduct piers), massproduced earthing bonds with several outputs have proven themselves. For orders of such types, drawings or sketches should be provided to ERICO with detailed information, such as spacing, lengths, connection pieces and cable cross section.

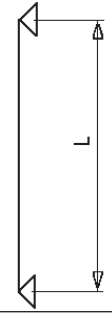

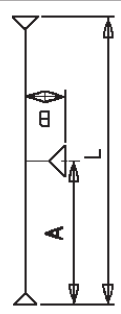
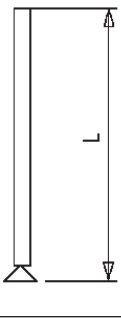
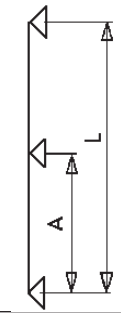
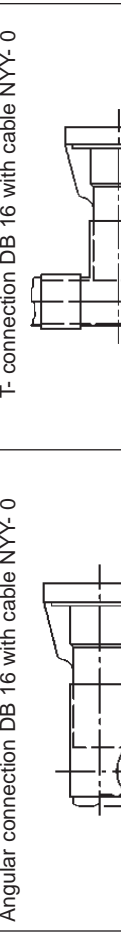
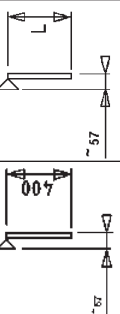
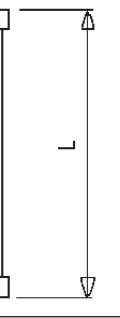
Standard lengths 500 and 1000 mm

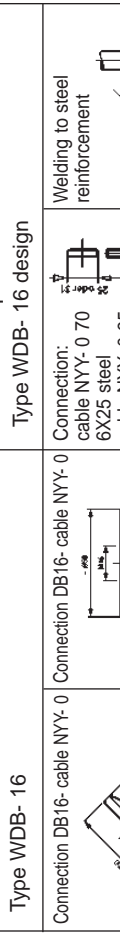
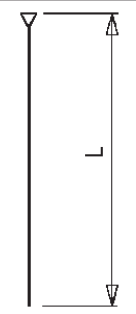
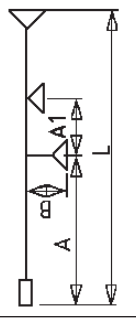
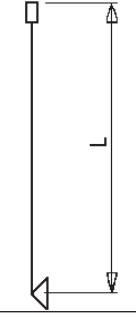
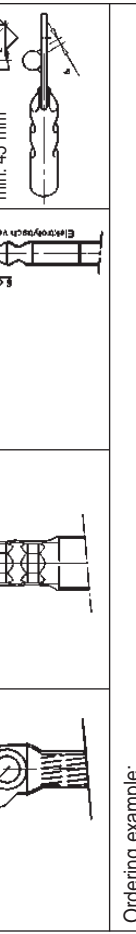
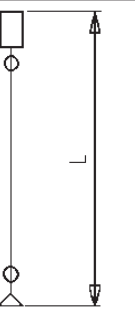
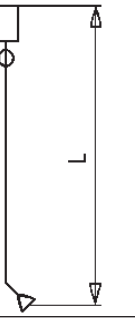
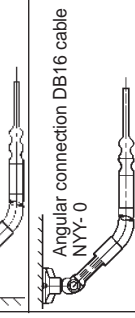
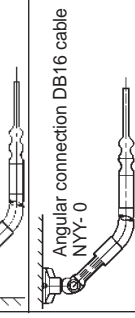
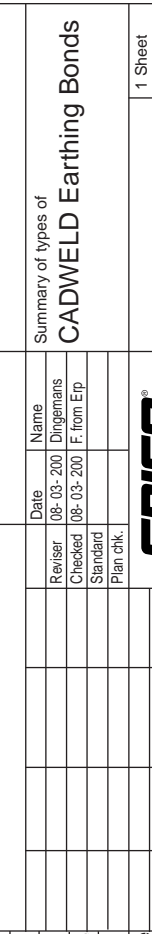
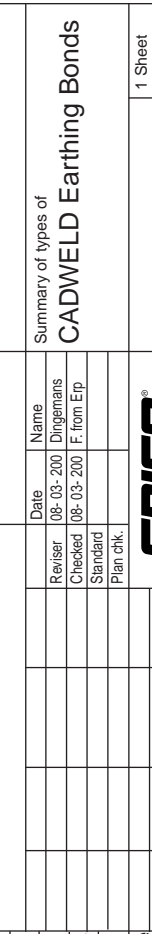
<p>FDB-16</p> 	<p>SDB-16</p> 	<p>WDB-16 Design 1</p> 	<p>Angular connection DB 16 with welding tongue</p>  <p>For construction 1 For construction 2</p> <p>Type KDB- 16</p>	<p>TDB-16</p> 	<p>EDB-16</p> 	<p>WDB-16 Design 2</p> 	<p>Angular connection DB 16 with cable NYY-0</p>  <p>For construction 1 For construction 2</p> <p>Type KDB- 16</p>	<p>KDB-16</p> 	<p>KDB/FF-16</p> 	<p>WDB-16 Design 4</p> 	<p>Linear connection DB 16 with cable NYY-0</p>  <p>For construction 1 For construction 2</p> <p>Type FDB- 16</p>	<p>KDB-16</p> 	<p>Special Design</p> 	<p>WDB-16 Design 7</p> 	<p>Angular connection DB 16 with cable NYY-0</p>  <p>For construction 1 For construction 2</p> <p>Type WDB- 16</p>	<p>FDB-16</p> 	<p>FDBS-16</p> 	<p>Linear connection DB16 cable NYY- 0</p>  <p>Angular connection DB16 cable NYY- 0</p> 	<p>Ordering example:</p> <p>... pieces TDB - 16 ... pieces SDB - 16 ... pieces FDBS - 16 ... pieces FDBSD - 16 ... pieces FDBSD - 16 Special designs only according to a sketch</p> <p>Construction 1 L = 2000 mm Construction 2 L = 500 mm</p> <p>L = 1000 mm A = 1000 mm B = 300 mm</p>	<p>Symbol</p> <p>Designation</p> <p>Application</p> <p>Const. 1 (l &lt; 25 kA) Const. 2 (l &gt; 25kA)</p> <p>Earth bond construction 1 (l &gt; 25KA) consisting of a cable NYY- 0 1x70 mms</p> <p>with welded-on earthing plate DB 16 and or welding tongue</p> <p>Earthing bonds of construction 2 (l &gt; 25KA) consisting of a cable NYY-0 1x95 mms with welded-on earthing plate DB 16 and or welding tongue</p> <p>With earthing links of construction 1 and 2 all earthing plate connections (welded on or pressed) and the compressed welding tongues are sheathed with heat-shrink sleeving</p>	<p>Usable for:</p> <p>Overhead line regulations of the DB</p>	<p>Connection:</p> <p>cable NYY- 0 70 6X25 steel cable NYY- 0 95 8X31 steel Weld seam</p> <p>Welding to steel reinforcement</p> <p>Length L per side min. 45 mm</p>	<p>Connection DB16- cable NYY- 0</p>  <p>Connection DB16- cable NYY- 0</p> 	<p>Issue</p> <p>Date</p> <p>Scale</p>	<p>Seen Frankfurt/Main TZF 73 on</p>	<p>3 Ebs. 15.03.19 BL. 1</p>	<p>Summary of types of CADWELD Earthing Bonds</p> <p>ERICO</p> <p>1 Sheet</p>
---	---	---	---	---	---	---	--	---	--	---	---	--	--	--	---	---	--	--	---	---	---	---	---	---------------------------------------	--------------------------------------	------------------------------	---

# Application Examples

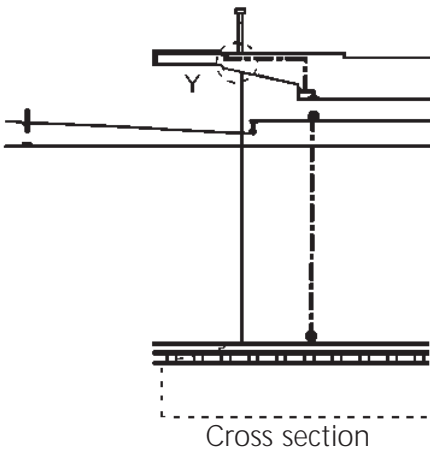

Example of a connection with an earthing connector

Hex. head screw M16x20  
 A4 ISO 4017  
 Alternative : CuNil. 5Si  
 Washer 18 DIN 126-Cu  
 Earthing bond  
 according to 4 Ebs. 15.03.17

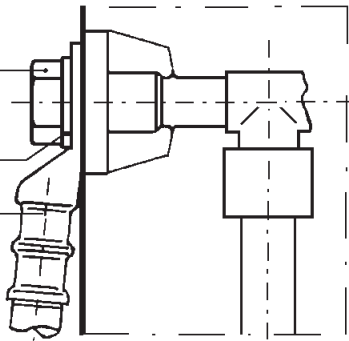

Earthing of railings in the case of bridges

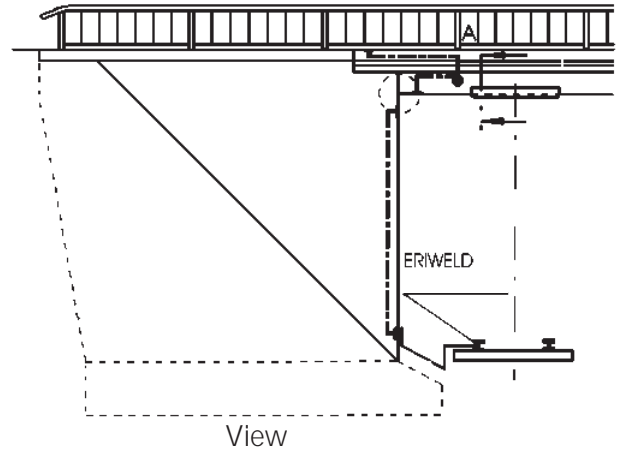

Example of a connection with wire 10 DIN 43 137-St34

Hex. head screw M16x25  
 A4 ISO 4017  
 Alternative : CuNil. 5Si  
 Washer 18 DIN 126-Cu  
 Wire 10 DIN 43137-St 34  
 3 Ebs 20.01.01

All screw connections are to be tightly fastened with a wrench.

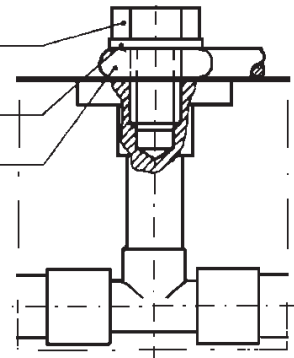

Connection for current collector stop rail

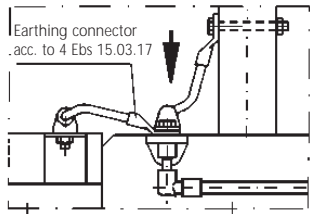

Protection against unintentional Cap contact  
 Detail Y

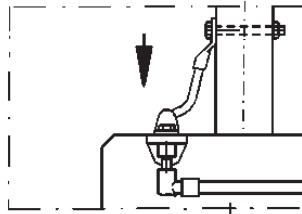

Detail Y

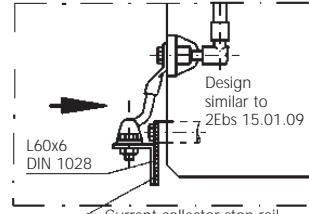

Cross section A-A

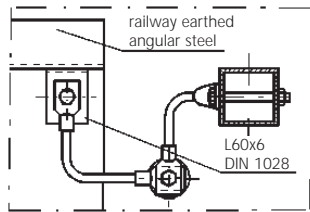

Detail Y in direction of arrow

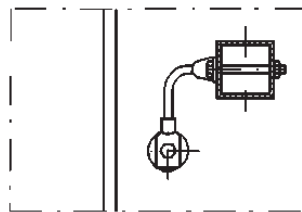

Detail Y in direction of arrow

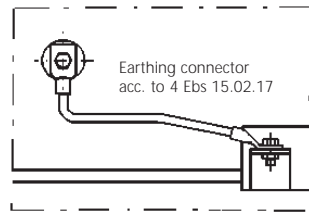

Cross section A-A in direction of arrow

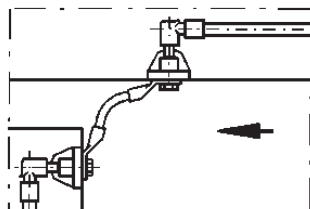

Detail Z

Bridging of:  
 Bridge pliers -  
 bridge decks  
 expansion joints,  
 concrete sections

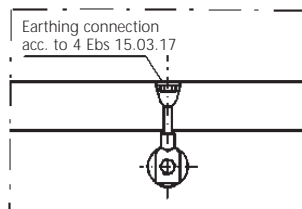

Detail Z in direction of arrow



## Measures to be taken for earthing when including slack reinforcement

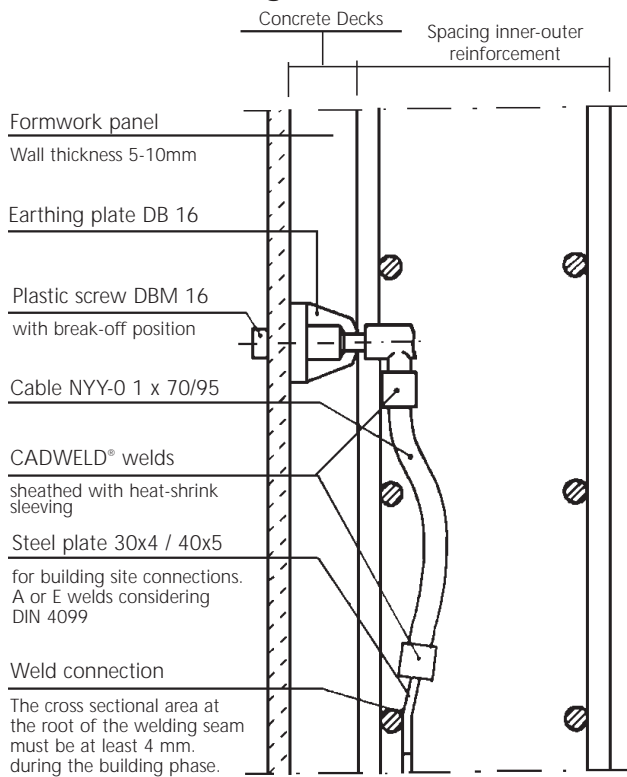

## Measures to be taken for earthing without including untensioned reinforcement

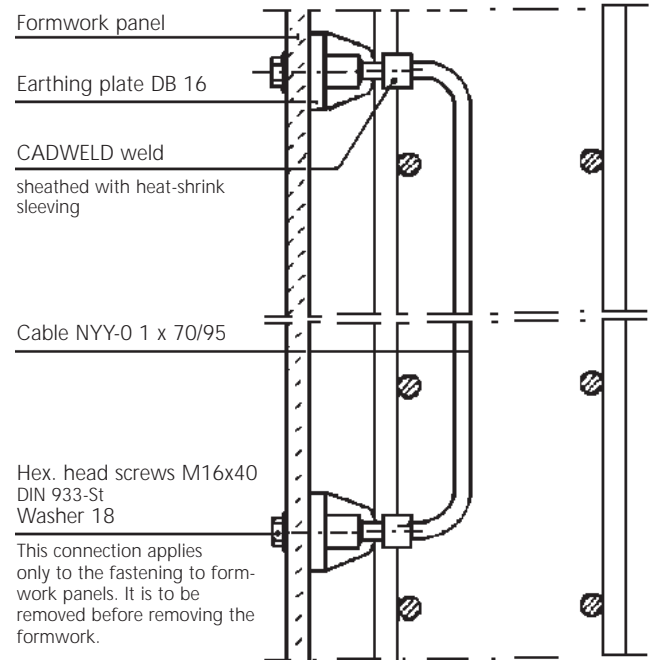

## Assembly information

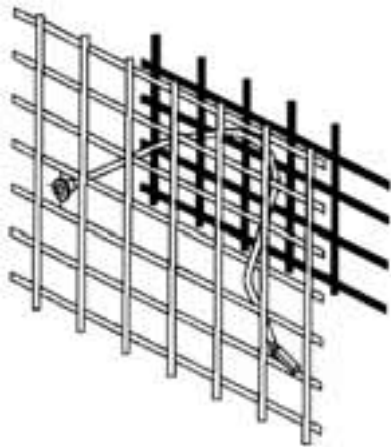

The fastening of the earthing plates to the formwork panels can also be made with nails using the plate indents. After removal of the formwork, the nail spikes that stick out are to be removed.

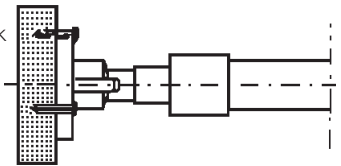

The protective label placed to the front side of the earthing plates serves as a thread protection during the construction phase. It is to be removed before connecting a conductor.



Accompanying drawings:  
 2 Ebs 02.05.19 3 Ebs 02.05.34  
 2 Ebs 15.01.09 4 Ebs 15.03.17  
 3 Ebs 20.01.01

Source of supply for earthing bonds:  
 ERICO Europe

This connection applies to reinforcement bars with a minimum diameter of 16 mm. For smaller bar diameters a longer steel welding plate has to be selected which has then to be welded to the smaller reinforcement bars more often, as it is appropriate.

By the use of a formwork panel the seating of the earthing plates are to be determined accurately through control holes. This seating may not be obstructed by reinforcement bars. When pressing on the reinforcement, sufficient space must remain for the earthing bonds.

The earthing plate has to be fastened firmly to the formwork panel with the plastic bolt DSM16. This bolt will not be removed until removing the formwork. The bolt head can easily be knocked off with a hammer, the remaining part protects the thread from subsequent damage and can finally be removed with a hexagonal socket key.

When installing earthing bonds it has to be ensured by using spacers or by repositioning the conductor cables that the bonds do not contact the formwork panel. Only a sufficient concrete decking protects against possible damage due to corrosion.

The concrete vibrators are to be handled carefully during compacting of the concrete near the earthing plates. Direct impact might result in breaking off the plastic screw.

Usable for:		<b>DB BZA Munich</b> Jan. 1992		2 Ebs 15.01.20	
Overhead line regulations		Dimensions without reference to tolerance DIN		Issue	
				Date	
Drawing revised		1.93	1991	Date	Name
			Reviser	21.11.	Stein
			Checked	01.92	
			Standard		
			Information about the arrangement of railway earthing on buildings with CADWELD type earthing bonds		
			CD 101.179e		
Changes		Date	Name	Orig. ERICO CD 101.143	Repl. for 2Ebs.15.01.20/05.85
					Repl. by
					Sheet 1
					1 Sheet

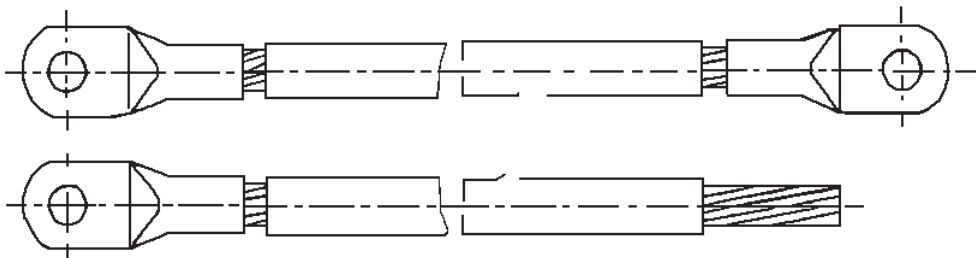

			1	1	2															Cable lug 4 Ebs 15.13.22/b
			1	1	2															Cable lug 4 Ebs 15.13.22/a
								1	2					1						Cable lug DIN 46 235 12-70-S
									1	2				1						Cable lug DIN 46 235 12-50-S
				1									1	1		2				Cable lug DIN 46 235 16-70-S
					1								1	1		2				Cable lug DIN 46 235 16-50-S
	1		1	1	1	1	1	1	1	1	1	1	1	1	1					Cable N YY-0 1 x70mm $\geq$
		1	1	1	1	1	1	1	1	1	1	1	1	1	1					Cable N YY-0 1 x50 mm $\geq$
Const.	r	q	p	o	n	m	l	k	j	i	h	g	f	e	d	c	b	a		Component
	i	i	660 571	660 570	660 567	660 565	660 564	660 562	666 854	666 853	666 852	666 851	660 573	660 572	660 575	660 574	660 569	660 568		

Construction a-d and g-h: Connection of components made of steel/copper<sup>1)</sup> with steel/copper<sup>1)</sup>  
 Construction e-f and i-j: Connection of components made of steel/copper<sup>1)</sup> with rail  
 Construction k-l: Connection of components made of aluminum with aluminum  
 Construction m-n: Connection of components made of steel/copper<sup>1)</sup> with aluminum  
 Construction p-o: Connection of components made of aluminum with rail  
 Construction q-r: Connection of rail with rail

Screws to be used: N 24 017, length as required

For components made of Al and Al alloys:

A2<sup>2)</sup>

made of Cu and Cu alloys:

A2<sup>2)</sup>

made of steel:

coating DIN 267, part 10; tZn

1) on Cu components also cable lug DIN 46235 12/16-50/70 permissible

2) bare with lubricant

3) length as required

4) state length of cable with order

Usable for:		<b>DB</b> Halle 20.05.97		4 Ebs. 15.03.17											
Overhead line regulations		NGT 52		Issue											
		Dimensions without reference to tolerance DIN		Date											
				Scale											
				Date	Name		<b>Overhead Line</b>								
				Reviser	19.05.97	Kurzbach									
				Checked											
				Standard											
Bem. with cross ref. to 3 Ebs 15.02.01 rem.		03.00		Deutsche Bahn AG Electrical and machine engineering Overhead line				<b>Earthing Connectors</b>							
Resp. Change		Date	Name	Orig.		Repl. for issue 09 95								Repl. by	
								Sheet		Sheet					

### 3. Reference

The following drawings and standards were used when creating this document:

- Technical release from 05.09.2001

- 3 Ebs. 15.03.19 BL.1 CADWELD - Earthing Bonds

- 2 Ebs. 15.01.20 Information about the arrangement of railway earthing on buildings with CADWELD type earthing bonds

- 4 Ebs. 15.03.17 Earthing connectors

TEL Frankfurt/Main  
TEL 2 Munich  
TZF 73 Frankfurt/Main  
ERICO GmbH

## Technical Release

1. The present technical release applies to the company

ERICO GmbH  
66851 Schwanemühle

2. The technical release applies to the supply of the following equipment to the DB AG:

FDBC-16 earthing bonds  
FDBS-16 earthing bonds

3. The following documentation, test certificates and other details were checked, and form the basis of the technical release:

- EBA authorization for electronic systems no.: 201090/8
- Investigation of the short circuit behavior, Report no.: 98471638.000-HVL 99-1322, of the KEMA Netherlands B.V.
- Separation testing by the company ERICO, Test report no.: PN0023T1
- Drawing 3 Ebs 15.03.19 Sht. 1

4. Additional condition:

5. The technical release presented is valid until revoked.

Frankfurt/Main, 05.09.2001

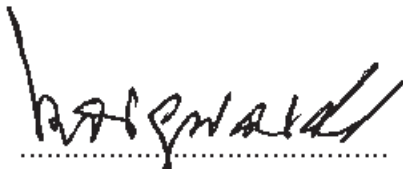
  
.....  
(Dipl.-Ing. Borgwardt)

# ERICO®



[www.erico.com](http://www.erico.com)



**AUSTRALIA**  
Phone 1-800-263-508  
Fax 1-800-423-091

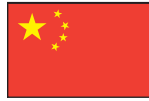

**CHINA**  
Phone +86-21-3430-4878  
Fax +86-21-5831-8177



**HUNGARY**  
Phone 06-800-16538  
Fax +39-0244-386-107



**NORWAY**  
Phone 800-100-73  
Fax 800-100-66



**SWITZERLAND**  
Phone 0800-55-86-97  
Fax 0800-55-96-15



**BELGIUM**  
Phone 0800-757-48  
Fax 0800-757-60



**DENMARK**  
Phone 808-89-372  
Fax 808-89-373



**INDONESIA**  
Phone +62-21-575-0941  
Fax +62-21-575-0942



**POLAND**  
Phone +48-71-349-04-60  
Fax +48-71-349-04-61



**THAILAND**  
Phone +66-2-267-5776  
Fax +66-2-636-6988



**BRAZIL**  
Phone +55-11-3623-4333  
Fax +55-11-3621-4066



**FRANCE**  
Phone 0-800-901-793  
Fax 0-800-902-024



**ITALY**  
Phone 800-870-938  
Fax 800-873-935



**SINGAPORE**  
Phone +65-6-268-3433  
Fax +65-6-268-1389



**UNITED ARAB  
EMIRATES**  
Phone +971-4-881-7250  
Fax +971-4-881-7270



**CANADA**  
Phone +1-800-677-9089  
Fax +1-800-677-8131



**GERMANY**  
Phone 0-800-189-0272  
Fax 0-800-189-0274



**MEXICO**  
Phone +52-55-5260-5991  
Fax +52-55-5260-3310



**SPAIN**  
Phone 900-993-154  
Fax 900-807-333



**UNITED KINGDOM**  
Phone 0808-2344-670  
Fax 0808-2344-676



**CHILE**  
Phone +56-2-370-2908  
Fax +56-2-369-5657



**HONG KONG**  
Phone +852-2764-8808  
Fax +852-2764-4486



**NETHERLANDS**  
Phone 0800-0200-135  
Fax 0800-0200-136



**SWEDEN**  
Phone 020-790-908  
Fax 020-798-964



**UNITED STATES**  
Phone 1-800-753-9221  
Fax +1-440-248-0723