

CADDY[®]

Cable Support Systems



Featuring the CADDY[®] CAT HP J-Hook System



ERICO[®]

Why CADDY® CAT HP?

Why Choose CADDY CAT HP over tray?

Fast and Easy to Install

- Much faster installation compared to conventional cable or ladder tray
- One person can install J-Hooks, tray installation requires two or more people
- No grounding or bonding required
- No extra components to install

Simpler Solution

- Tray requires an additional support structure - CADDY CAT HP does not
- Eliminates the need for special tools or connection fittings
- J-Hooks allow for easy, no-cost directional and level changes

J-Hooks are available pre-galvanized or painted to aid in the identification and organization of the pathway application



Why Choose CADDY CAT HP over other non-continuous supports?

- Designed to help meet the requirements for high performance data cables; suitable for power cables
- Sturdy steel construction with superior cable capacity and load rating
- Fire rated solution to comply with project requirements

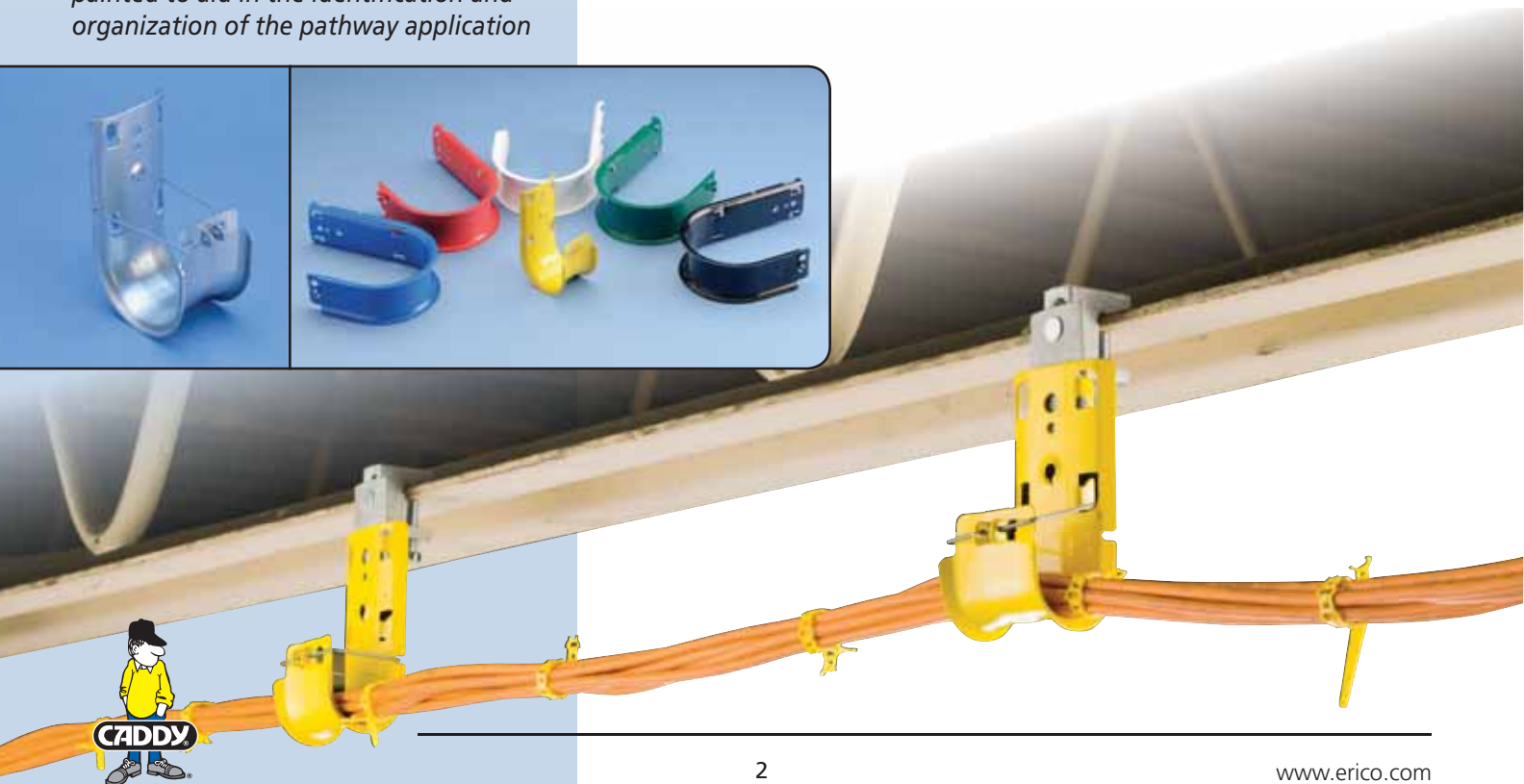

Designed to help meet the requirements for high performance data cables

The highly engineered CADDY CAT HP J-Hooks feature a 76 mm bend radius and comply with TIA standards for CAT 6A, CAT 7, and fiber optic cables. Many alternative J-Hook products do not meet the minimum bend radius required to install or support modern high performance data cables.

Cable Type	Avg. Diameter	Bend Radius Requirement	Minimal Bend Radius	CADDY CAT HP J-Hooks	Competitors with a 25 mm bend radius
CAT 5e	5.3 mm	4X	21.3 mm	✓	✓
CAT 6	5.8 mm	4X	23.4 mm	✓	✓
CAT 6A	7.6 mm	4X	30.5 mm	✓	✗
CAT 7 (SFTP)	7.4 mm	8X	58.9 mm	✓	✗
FIBER OPTIC (PLENUM)	5.1 mm	10 – 15X	50 - 75 mm	✓	✗

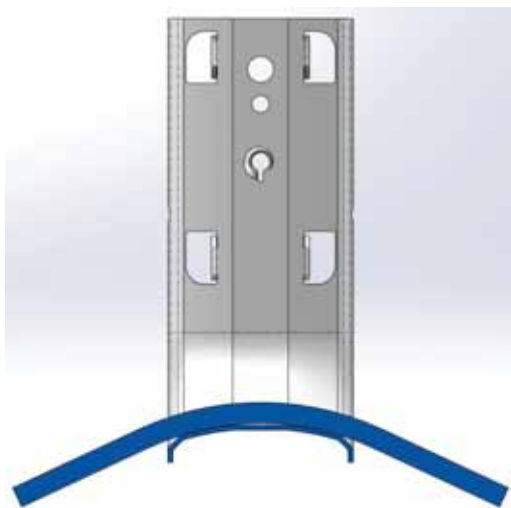

The J-Hooks have a wide base design and smooth beveled edges to provide a large bending radius for current and future high-performance data cables and fibre optics.

Sturdy steel construction with superior cable capacity and load rating

CADDY CAT HP J-Hooks feature superior stamped steel construction and up to 100 mm diameter carrying capacity that can support up to 140 CAT 6A or CAT 7 high performance cables. CADDY CAT HP J-Hooks are tested and certified to an industry-leading static load rating of up to 270 Newtons.

Fire rated solution to comply with project requirements

CADDY CAT HP J-Hooks have been tested to DIN 4102-12 and meet a range of requirements from E30 to E90. When project specifications call for a fire rated cable pathway, CADDY CAT HP J-Hooks are an ideal solution.



J-Hooks and cables in fire chamber before fire test



CADDY® CAT HP Components

Features:

- **Fully-versatile** J-Hook solution with interchangeable fasteners and support brackets
- Ideal for projects that require flexibility to adapt cable pathways on the jobsite
- Customized J-Hook trees can be easily assembled with various J-Hook sizes, colors and configurations
- Multiple color options aid in the identification and organization of the pathway application



Flange



Purlin



Rod /
Wire



Tree
Bracket



Pedestal



Angle
Bracket



Straight
Bracket

Component Assembly



J-Hook Tree Assembly



CADDY® CAT HP Assemblies

Features:

- **Pre-assembled;** saving installation time & labor
- Ideal for new construction or when the structural attachment requirements are well understood
- Provides optimal support for high-performance data cable*, including CAT 6, CAT 6A, CAT 7 and fiber optics
- Single- or double-sided tree configurations provide multiple J-Hooks with one structural attachment



J-Hook to
Flange



J-Hook to
Rod / Wire



J-Hook to
T-Grid



J-Hook to
Concrete



J-Hook to
Pedestal



**Pre-Assembled
Trees Available**

* CADDY® CAT HP meets TIA-568-C and TIA-569-C requirements

Cable Support Systems



CADDY® CAT HP J-HOOK SYSTEM

PAGES 7-37

Our most advanced J-Hook support solution. Highly engineered features help to ensure a stable and secure installation for high-performance cables.



CADDY® CAT CM CABLE SUPPORT SYSTEM

PAGES 38-41

Specially designed U-Hooks and double J-Hooks have large-diameter, rounded support surfaces/edges to avoid overbending and kinking of cables.



CADDY® CAT 425 ADJUSTABLE CABLE SUPPORTS

PAGES 42-46

Adjustable fabric cable support can be mounted to overhead building structure or wall-mounted for low-profile installations.



CADDY® CAT HP J-Hook System



CADDY® CAT HP J-HOOK

The CADDY® CAT HP J-Hook System is an advanced, non-continuous pathway support solution for today's high-performance cabling systems. Highly engineered features help ensure a stable and secure installation that complies with industry codes and standards for high-performance cables.

The CADDY CAT HP System is a cost-effective alternative to using wire mesh cable tray, ladder tray or similar complex alternatives. It requires significantly less material and installs in a fraction of the time of other methods. This versatile solution accommodates a wide range of attachment methods and is available as individual J-Hooks, pre-built CADDY® CAT HP assemblies and multi-tiered trees, as well as interchangeable CADDY® CAT HP components. The CADDY CAT HP J-Hook System provides the perfect combination of performance, time savings and versatility required by today's datacom and electrical contractors.

- Provides optimal support for high-performance data cable, up to and including Cat 5e, Cat 6, Cat 6A, Cat 7 and fibre optic
- Typically requires less time, labor and material for installation compared to cable tray systems
- Requires no screws, rivets or special tools for assembly
- Provides superior fill capacity and load rating over most other non-continuous cable support alternatives
- Offers a variety of attachment methods
- Engineered to accommodate future emerging data cables
- Recyclable and is produced with up to 80% recycled steel
- Uses up to 88% less material by weight than traditional cable tray methods
- Complies with EN 50174-2
- Meets ISO®/IEC™ 14763-2, TIA 568-C and TIA 569-C



CADDY® CAT HP J-Hook PAGES 7-9

Non-continuous pathway support solution with a wide base design and smooth beveled edges to provide a large bending radius for high-performance data cables and fibre optics.



CADDY® CAT HP Assemblies PAGE 10-22

Pre-built assemblies comprising a high-performance J-Hook and structure attachment, ready to use out of the box.



CADDY® CAT HP J-Hook Trees PAGES 23-36

Pre-assembled trees comprising structural attachment and multiple tiers of CADDY® CAT HP J-Hooks in single- or double-sided configurations for segregating cable runs.



CADDY® CAT HP Components PAGES 27-35

Structure attachments and brackets for linking high performance J-Hooks to building structure or to each other in tree configurations.



CADDY® CAT HP Accessories PAGES 36-37

Accessories for the CADDY® CAT HP System, designed to simplify installation.

CADDY® CAT HP J-Hook

CADDY® CAT HP J-HOOK

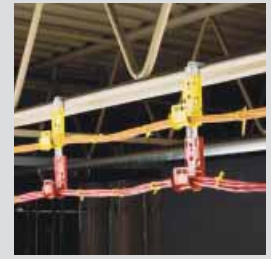

CADDY® CAT HP J-Hooks are the heart of the CADDY® CAT HP System. The J-Hooks have a wide base design and smooth beveled edges to provide a large bending radius for current and future high-performance data cables and fibre optics. CADDY CAT HP J-Hooks are available in a wide range of sizes to offer a solution that meets industry standards for Cat 6A and easily accommodates Cat 7, large-diameter fibre optic, innerduct and coax cable. Individual CADDY CAT HP J-Hooks can be fastened directly to the building structure or can be used to expand existing CADDY CAT HP J-Hook cable supports. The J-Hooks are designed to provide a strong and stable pathway support installation.

- Provides optimal support for high-performance data cable, up to and including Cat 5e, Cat 6, Cat 6A, Cat 7 and fibre optic
- Rounded edges on J-Hooks provide proper bend radius support for high performance data cables
- Multiple color options aid in the identification and organization of the pathway application
- Provides superior fill capacity and load rating over most other non-continuous cable support alternatives
- Tested according to DIN 4102-12
- Complies with EN 50174-2
- Meets ISO®/IEC™ 14763-2, TIA 568-C and TIA 569-C
- Painted J-Hooks are low-smoke and halogen-free

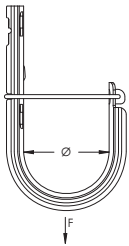

Material: Steel



Part Number	Article Number	Diameter Ø	Area	Cable Capacity, Cat 5e	Cable Capacity, Cat 6	Cable Capacity, Cat 6A	Static Load F
Finish: Pre-galvanized							
CAT16HP	181061	25.0 mm	690 mm ²	20	15	10	270 N
CAT21HP	181188	33.3 mm	1,174 mm ²	50	40	25	270 N
CAT32HP	181062	50.0 mm	2,561 mm ²	90	60	35	270 N
CAT48HP	181063	75.0 mm	5,974 mm ²	200	150	80	270 N
CAT64HP	181064	100.0 mm	9,987 mm ²	330	220	140	270 N

Click on any of the part numbers throughout this brochure for more product information on the ERICO website!



Part Number	Article Number	Diameter Ø	Area	Cable Capacity, Cat 5e	Cable Capacity, Cat 6	Cable Capacity, Cat 6A	Static Load F
Finish: Pre-galvanized, Painted – Color: Black							
CAT16HPBA	181255	25.0 mm	690 mm ²	20	15	10	270 N
CAT21HPBA	181185	33.3 mm	1,174 mm ²	50	40	25	270 N
CAT32HPBA	181115	50.0 mm	2,561 mm ²	90	60	35	270 N
CAT48HPBA	181125	75.0 mm	5,974 mm ²	200	150	80	270 N
CAT64HPBA	181135	100.0 mm	9,987 mm ²	330	220	140	270 N
Finish: Pre-galvanized, Painted – Color: Blue							
CAT16HPBU	181252	25.0 mm	690 mm ²	20	15	10	270 N
CAT21HPBU	181182	33.3 mm	1,174 mm ²	50	40	25	270 N
CAT32HPBU	181112	50.0 mm	2,561 mm ²	90	60	35	270 N
CAT48HPBU	181122	75.0 mm	5,974 mm ²	200	150	80	270 N
CAT64HPBU	181132	100.0 mm	9,987 mm ²	330	220	140	270 N
Finish: Pre-galvanized, Painted – Color: Green							
CAT16HPGR	181256	25.0 mm	690 mm ²	20	15	10	270 N
CAT21HPGR	181186	33.3 mm	1,174 mm ²	50	40	25	270 N
CAT32HPGR	181116	50.0 mm	2,561 mm ²	90	60	35	270 N
CAT48HPGR	181126	75.0 mm	5,974 mm ²	200	150	80	270 N
CAT64HPGR	181136	100.0 mm	9,987 mm ²	330	220	140	270 N
Finish: Pre-galvanized, Painted – Color: Orange							
CAT16HPOR	181257	25.0 mm	690 mm ²	20	15	10	270 N
CAT21HPOR	181187	33.3 mm	1,174 mm ²	50	40	25	270 N
CAT32HPOR	181117	50.0 mm	2,561 mm ²	90	60	35	270 N
CAT48HPOR	181127	75.0 mm	5,974 mm ²	200	150	80	270 N
CAT64HPOR	181137	100.0 mm	9,987 mm ²	330	220	140	270 N
Finish: Pre-galvanized, Painted – Color: Red							
CAT16HPRD	181251	25.0 mm	690 mm ²	20	15	10	270 N
CAT21HPRD	181181	33.3 mm	1,174 mm ²	50	40	25	270 N
CAT32HPRD	181111	50.0 mm	2,561 mm ²	90	60	35	270 N
CAT48HPRD	181121	75.0 mm	5,974 mm ²	200	150	80	270 N
CAT64HPRD	181131	100.0 mm	9,987 mm ²	330	220	140	270 N
Finish: Pre-galvanized, Painted – Color: White							
CAT16HPWH	181253	25.0 mm	690 mm ²	20	15	10	270 N
CAT21HPWH	181183	33.3 mm	1,174 mm ²	50	40	25	270 N
CAT32HPWH	181113	50.0 mm	2,561 mm ²	90	60	35	270 N
CAT48HPWH	181123	75.0 mm	5,974 mm ²	200	150	80	270 N
CAT64HPWH	181133	100.0 mm	9,987 mm ²	330	220	140	270 N
Finish: Pre-galvanized, Painted – Color: Yellow							
CAT16HPYL	181254	25.0 mm	690 mm ²	20	15	10	270 N
CAT21HPYL	181184	33.3 mm	1,174 mm ²	50	40	25	270 N
CAT32HPYL	181114	50.0 mm	2,561 mm ²	90	60	35	270 N
CAT48HPYL	181124	75.0 mm	5,974 mm ²	200	150	80	270 N
CAT64HPYL	181134	100.0 mm	9,987 mm ²	330	220	140	270 N

Non-continuous supports may not exceed spacing of 5' (1.5 m) per TIA 569-C.9.7 and EN 50174-2.
Cable capacity is calculated based on a 70% fill rate.

CADDY® CAT HP Assemblies



CADDY® CAT HP assemblies are the fastest CATs in the CADDY® CAT HP family by providing a high-performance J-Hook solution in a single assembly. They are ready to use right out of the box with a broad range of attachment methods. CADDY CAT HP assemblies are ideal for new construction or when the structural attachment requirements are well understood and installation speed is critical.

- Provides optimal support for high-performance data cable, up to and including Cat 5e, Cat 6, Cat 6A, Cat 7 and fibre optic
- Ready to use out of the box, saving installation time and labor
- Available in a variety of attachment methods, including beam flanges, purlin, rod or wire, T-Grid and other common mounting configurations
- Provides superior fill capacity and load rating over most other non-continuous cable support alternatives
- Meets ISO/IECSM 14763-2, TIA 568-C and TIA 569-C

CADDY® CAT HP ASSEMBLIES



CADDY® CAT HP
J-Hook to Flange



CADDY® CAT HP
J-Hook to Purlin



CADDY® CAT HP
J-Hook to Rod/Wire



CADDY® CAT HP
J-Hook to Concrete



CADDY® CAT HP
J-Hook to Pedestal



CADDY® CAT HP
J-Hook to Strut



CADDY® CAT HP
J-Hook to T-Grid



CADDY® CAT HP J-Hook with BC200 Beam Clamp

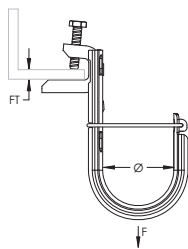

- Easy installation to beam flanges
- Provides optimal support for high-performance data cable, up to and including Cat 5e, Cat 6, Cat 6A, Cat 7 and fibre optic
- Provides superior fill capacity and load rating over most other non-continuous cable support alternatives
- Rounded edges on J-Hooks provide proper bend radius support for high performance data cables
- Cost effective alternative to expensive cable tray
- Complies with EN 50174-2
- Meets ISO/IECSM 14763-2, TIA 568-C and TIA 569-C

Material: Steel

Finish: Pre-galvanized



Part Number	Article Number	Diameter Ø	Area	Cable Capacity, Cat 5e	Cable Capacity, Cat 6	Cable Capacity, Cat 6A	Flange Thickness FT	Static Load F
CAT16HPBC200	181014	25.0 mm	690 mm ²	20	15	10	16 mm Max	270 N
CAT21HPBC200	181239	33.3 mm	1,174 mm ²	50	40	25	16 mm Max	270 N
CAT32HPBC200	181015	50.0 mm	2,561 mm ²	90	60	35	16 mm Max	270 N
CAT48HPBC200	181236	75.0 mm	5,974 mm ²	200	150	80	16 mm Max	270 N
CAT64HPBC200	181016	100.0 mm	9,987 mm ²	330	220	140	16 mm Max	270 N

Setscrew must be tightened and torqued onto the sloped side of the I-beam.

Non-continuous supports may not exceed spacing of 5' (1.5 m) per TIA 569-C.9.7 and EN 50174-2.

Cable capacity is calculated based on a 70% fill rate.

CADDY® CAT HP ASSEMBLIES

CADDY® CAT HP J-Hook with BC200 Beam Clamp, Swivel

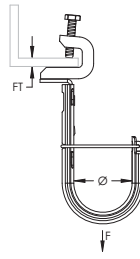

- Easy installation to beam flanges
- Rotates to support various directional runs of cable
- Provides optimal support for high-performance data cable, up to and including Cat 5e, Cat 6, Cat 6A, Cat 7 and fibre optic
- Provides superior fill capacity and load rating over most other non-continuous cable support alternatives
- Rounded edges on J-Hooks provide proper bend radius support for high performance data cables
- Cost effective alternative to expensive cable tray
- Complies with EN 50174-2
- Meets ISO/IECSM 14763-2, TIA 568-C and TIA 569-C

Material: Steel
Finish: Pre-galvanized



Part Number	Article Number	Diameter Ø	Area	Cable Capacity, Cat 5e	Cable Capacity, Cat 6	Cable Capacity, Cat 6A	Flange Thickness FT	Static Load F
CAT16HPBC200B	181017	25.0 mm	690 mm ²	20	15	10	16 mm Max	270 N
CAT21HPBC200B	181246	33.3 mm	1,174 mm ²	50	40	25	16 mm Max	270 N
CAT32HPBC200B	181018	50.0 mm	2,561 mm ²	90	60	35	16 mm Max	270 N
CAT48HPBC200B	181237	75.0 mm	5,974 mm ²	200	150	80	16 mm Max	270 N
CAT64HPBC200B	181019	100.0 mm	9,987 mm ²	330	220	140	16 mm Max	270 N

Setscrew must be tightened and torqued onto the sloped side of the I-beam.
Non-continuous supports may not exceed spacing of 5' (1.5 m) per TIA 569-C.9.7 and EN 50174-2.
Cable capacity is calculated based on a 70% fill rate.

CADDY® CAT HP ASSEMBLIES



CADDY® CAT HP J-Hook with BC Beam Clamp

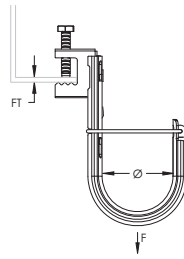

- Easy installation to beam flanges
- Provides optimal support for high-performance data cable, up to and including Cat 5e, Cat 6, Cat 6A, Cat 7 and fibre optic
- Provides superior fill capacity and load rating over most other non-continuous cable support alternatives
- Rounded edges on J-Hooks provide proper bend radius support for high performance data cables
- Cost effective alternative to expensive cable tray
- Complies with EN 50174-2
- Meets ISO®/IEC™ 14763-2, TIA 568-C and TIA 569-C

Material: Steel, Spring Steel
 Finish: Pre-galvanized, CADDY® ARMOUR



Part Number	Article Number	Diameter Ø	Area	Cable Capacity, Cat 5e	Cable Capacity, Cat 6	Cable Capacity, Cat 6A	Flange Thickness FT	Static Load F
CAT16HPBC	181201	25.0 mm	690 mm ²	20	15	10	16 mm Max	270 N
CAT21HPBC	181238	33.3 mm	1,174 mm ²	50	40	25	16 mm Max	270 N
CAT32HPBC	181202	50.0 mm	2,561 mm ²	90	60	35	16 mm Max	270 N
CAT48HPBC	181203	75.0 mm	5,974 mm ²	220	140	80	16 mm Max	270 N
CAT64HPBC	181204	100.0 mm	9,987 mm ²	330	220	140	16 mm Max	270 N

Non-continuous supports may not exceed spacing of 5' (1.5 m) per TIA 569-C.9.7 and EN 50174-2.
 Cable capacity is calculated based on a 70% fill rate.

CADDY® CAT HP J-Hook with BC Beam Clamp, Swivel

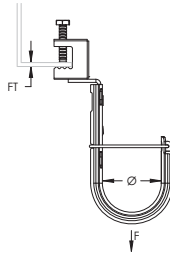

- Easy installation to beam flanges
- Rotates to support various directional runs of cable
- Provides optimal support for high-performance data cable, up to and including Cat 5e, Cat 6, Cat 6A, Cat 7 and fibre optic
- Provides superior fill capacity and load rating over most other non-continuous cable support alternatives
- Rounded edges on J-Hooks provide proper bend radius support for high performance data cables
- Cost effective alternative to expensive cable tray
- Complies with EN 50174-2
- Meets ISO/IECSM 14763-2, TIA 568-C and TIA 569-C

Material: Steel, Spring Steel
 Finish: Pre-galvanized, CADDY® ARMOUR



CADDY® CAT HP ASSEMBLIES

Part Number	Article Number	Diameter Ø	Area	Cable Capacity, Cat 5e	Cable Capacity, Cat 6	Cable Capacity, Cat 6A	Flange Thickness FT	Static Load F
CAT16HPBCB	181219	25.0 mm	690 mm ²	20	15	10	16 mm Max	270 N
CAT21HPBCB	181245	33.3 mm	1,174 mm ²	50	40	25	16 mm Max	270 N
CAT32HPBCB	181221	50.0 mm	2,561 mm ²	90	60	35	16 mm Max	270 N
CAT48HPBCB	181222	75.0 mm	5,974 mm ²	200	150	80	16 mm Max	270 N
CAT64HPBCB	181021	100.0 mm	9,987 mm ²	330	220	140	16 mm Max	270 N

Non-continuous supports may not exceed spacing of 5' (1.5 m) per TIA 569-C.9.7 and EN 50174-2.
 Cable capacity is calculated based on a 70% fill rate.



CADDY® CAT HP J-Hook with Hammer-On Flange Clip

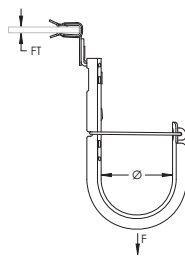

- Requires only a hammer to install
- Provides optimal support for high-performance data cable, up to and including Cat 5e, Cat 6, Cat 6A, Cat 7 and fibre optic
- Provides superior fill capacity and load rating over most other non-continuous cable support alternatives
- Rounded edges on J-Hooks provide proper bend radius support for high performance data cables
- Cost effective alternative to expensive cable tray
- Complies with EN 50174-2
- Meets ISO®/IEC™ 14763-2, TIA 568-C and TIA 569-C

Material: Steel, Spring Steel
Finish: Pre-galvanized, CADDY® ARMOUR



Part Number	Article Number	Diameter Ø	Area	Cable Capacity, Cat 5e	Cable Capacity, Cat 6	Cable Capacity, Cat 6A	Flange Thickness FT	Static Load F
CAT16HP24SM	181098	25.0 mm	690 mm ²	20	15	10	3 – 6 mm	270 N
CAT16HP58SM	181151	25.0 mm	690 mm ²	20	15	10	8 – 14 mm	270 N
CAT16HP912SM	181152	25.0 mm	690 mm ²	20	15	10	14 – 20 mm	270 N
CAT21HP24SM	181197	33.3 mm	1,174 mm ²	50	40	25	3 – 6 mm	270 N
CAT21HP58SM	181198	33.3 mm	1,174 mm ²	50	40	25	8 – 14 mm	270 N
CAT21HP912SM	181199	33.3 mm	1,174 mm ²	50	40	25	14 – 20 mm	270 N
CAT32HP24SM	181099	50.0 mm	2,561 mm ²	90	60	35	3 – 6 mm	270 N
CAT32HP58SM	181154	50.0 mm	2,561 mm ²	90	60	35	8 – 14 mm	270 N
CAT32HP912SM	181155	50.0 mm	2,561 mm ²	90	60	35	14 – 20 mm	270 N
CAT48HP24SM	181207	75.0 mm	5,974 mm ²	200	150	80	3 – 6 mm	270 N
CAT48HP58SM	181157	75.0 mm	5,974 mm ²	200	150	80	8 – 14 mm	270 N
CAT48HP912SM	181158	75.0 mm	5,974 mm ²	200	150	80	14 – 20 mm	270 N
CAT64HP24SM	181208	100.0 mm	9,987 mm ²	330	220	140	3 – 6 mm	270 N
CAT64HP58SM	181161	100.0 mm	9,987 mm ²	330	220	140	8 – 14 mm	270 N
CAT64HP912SM	181162	100.0 mm	9,987 mm ²	330	220	140	14 – 20 mm	270 N

Non-continuous supports may not exceed spacing of 5' (1.5 m) per TIA 569-C.9.7 and EN 50174-2.
Cable capacity is calculated based on a 70% fill rate.

CADDY® CAT HP J-Hook with Hammer-On Flange Clip, Swivel

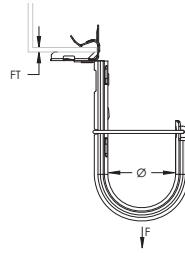

- Requires only a hammer to install
- Rotates to support various directional runs of cable
- Provides optimal support for high-performance data cable, up to and including Cat 5e, Cat 6, Cat 6A, Cat 7 and fibre optic
- Provides superior fill capacity and load rating over most other non-continuous cable support alternatives
- Rounded edges on J-Hooks provide proper bend radius support for high performance data cables
- Cost effective alternative to expensive cable tray
- Complies with EN 50174-2
- Meets ISO/IECSM 14763-2, TIA 568-C and TIA 569-C

Material: Steel, Spring Steel
Finish: Pre-galvanized, CADDY® ARMOUR



CADDY® CAT HP ASSEMBLIES

Part Number	Article Number	Diameter Ø	Area	Cable Capacity, Cat 5e	Cable Capacity, Cat 6	Cable Capacity, Cat 6A	Flange Thickness FT	Static Load F
CAT16HP24	181213	25.0 mm	690 mm ²	20	15	10	3 – 6 mm	270 N
CAT16HP58	181001	25.0 mm	690 mm ²	20	15	10	8 – 14 mm	270 N
CAT16HP912	181004	25.0 mm	690 mm ²	20	15	10	14 – 20 mm	270 N
CAT21HP24	181194	33.3 mm	1,174 mm ²	50	40	25	3 – 6 mm	270 N
CAT21HP58	181195	33.3 mm	1,174 mm ²	50	40	25	8 – 14 mm	270 N
CAT21HP912	181196	33.3 mm	1,174 mm ²	50	40	25	14 – 20 mm	270 N
CAT32HP24	181214	50.0 mm	2,561 mm ²	90	60	35	3 – 6 mm	270 N
CAT32HP58	181002	50.0 mm	2,561 mm ²	90	60	35	8 – 14 mm	270 N
CAT32HP912	181005	50.0 mm	2,561 mm ²	90	60	35	14 – 20 mm	270 N
CAT48HP24	181215	75.0 mm	5,974 mm ²	200	150	80	3 – 6 mm	270 N
CAT48HP58	181231	75.0 mm	5,974 mm ²	200	150	80	8 – 14 mm	270 N
CAT48HP912	181232	75.0 mm	5,974 mm ²	200	150	80	14 – 20 mm	270 N
CAT64HP24	181216	100.0 mm	9,987 mm ²	330	220	140	3 – 6 mm	270 N
CAT64HP58	181003	100.0 mm	9,987 mm ²	330	220	140	8 – 14 mm	270 N
CAT64HP912	181006	100.0 mm	9,987 mm ²	330	220	140	14 – 20 mm	270 N

Non-continuous supports may not exceed spacing of 5' (1.5 m) per TIA 569-C.9.7 and EN 50174-2.
Cable capacity is calculated based on a 70% fill rate.



CADDY® CAT HP J-Hook with C Purlin Clip

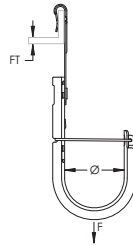

- Requires only a hammer to install
- Provides optimal support for high-performance data cable, up to and including Cat 5e, Cat 6, Cat 6A, Cat 7 and fibre optic
- Provides superior fill capacity and load rating over most other non-continuous cable support alternatives
- Rounded edges on J-Hooks provide proper bend radius support for high performance data cables
- Cost effective alternative to expensive cable tray
- Complies with EN 50174-2
- Meets ISO®/IEC™ 14763-2, TIA 568-C and TIA 569-C

Material: Steel, Spring Steel

Finish: Pre-galvanized, CADDY® ARMOUR



Part Number	Article Number	Diameter Ø	Area	Cable Capacity, Cat 5e	Cable Capacity, Cat 6	Cable Capacity, Cat 6A	Flange Thickness FT	Static Load F
CAT16HPVF14	181145	25.0 mm	690 mm ²	20	15	10	1.5 – 6.0 mm	270 N
CAT21HPVF14	181249	33.3 mm	1,174 mm ²	50	40	25	1.5 – 6.0 mm	270 N
CAT32HPVF14	181146	50.0 mm	2,561 mm ²	90	60	35	1.5 – 6.0 mm	270 N
CAT48HPVF14	181147	75.0 mm	5,974 mm ²	200	150	80	1.5 – 6.0 mm	270 N
CAT64HPVF14	181148	100.0 mm	9,987 mm ²	330	220	140	1.5 – 6.0 mm	270 N

Non-continuous supports may not exceed spacing of 5' (1.5 m) per TIA 569-C.9.7 and EN 50174-2.

Cable capacity is calculated based on a 70% fill rate.

CADDY® CAT HP J-Hook with Z Purlin Clip

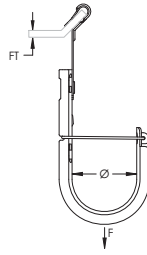

- Requires only a hammer to install
- Provides optimal support for high-performance data cable, up to and including Cat 5e, Cat 6, Cat 6A, Cat 7 and fibre optic
- Provides superior fill capacity and load rating over most other non-continuous cable support alternatives
- Rounded edges on J-Hooks provide proper bend radius support for high performance data cables
- Cost effective alternative to expensive cable tray
- Complies with EN 50174-2
- Meets ISO/IECSM 14763-2, TIA 568-C and TIA 569-C

Material: Steel, Spring Steel
Finish: Pre-galvanized, CADDY® ARMOUR



Part Number	Article Number	Diameter Ø	Area	Cable Capacity, Cat 5e	Cable Capacity, Cat 6	Cable Capacity, Cat 6A	Flange Thickness FT	Static Load F
CAT16HPAF14	181141	25.0 mm	690 mm ²	20	15	10	1.5 – 6.0 mm	270 N
CAT21HPAF14	181248	33.3 mm	1,174 mm ²	50	40	25	1.5 – 6.0 mm	270 N
CAT32HPAF14	181142	50.0 mm	2,561 mm ²	90	60	35	1.5 – 6.0 mm	270 N
CAT48HPAF14	181143	75.0 mm	5,974 mm ²	200	150	80	1.5 – 6.0 mm	270 N
CAT64HPAF14	181144	100.0 mm	9,987 mm ²	330	220	140	1.5 – 6.0 mm	270 N

Non-continuous supports may not exceed spacing of 5' (1.5 m) per TIA 569-C.9.7 and EN 50174-2.
Cable capacity is calculated based on a 70% fill rate.

CADDY® CAT HP ASSEMBLIES



CADDY® CAT HP J-Hook with Multi-Function Clip

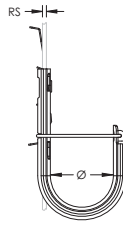

- Quick attachment to threaded rod or wire
- Provides optimal support for high-performance data cable, up to and including Cat 5e, Cat 6, Cat 6A, Cat 7 and fibre optic
- Provides superior fill capacity and load rating over most other non-continuous cable support alternatives
- Rounded edges on J-Hooks provide proper bend radius support for high performance data cables
- Cost effective alternative to expensive cable tray
- Complies with EN 50174-2
- Meets ISO®/IECSM 14763-2, TIA 568-C and TIA 569-C

Material: Steel, Spring Steel

Finish: Pre-galvanized, CADDY® ARMOUR



Part Number	Article Number	Diameter Ø	Area	Cable Capacity, Cat 5e	Cable Capacity, Cat 6	Cable Capacity, Cat 6A	Rod Size RS	Wire Size	Static Load F
CAT16HP4Z34	181217	25.0 mm	690 mm ²	20	15	10	M4, M6, M8	4.8 – 6.4 mm	130 N
CAT16HP6Z34	181007	25.0 mm	690 mm ²	20	15	10	M8, M10, M12	–	130 N
CAT21HP4Z34	181258	33.3 mm	1,174 mm ²	50	40	25	M4, M6, M8	4.8 – 6.4 mm	130 N
CAT21HP6Z34	181259	33.3 mm	1,174 mm ²	50	40	25	M8, M10, M12	–	130 N
CAT32HP4Z34	181218	50.0 mm	2,561 mm ²	90	60	35	M4, M6, M8	4.8 – 6.4 mm	130 N
CAT32HP6Z34	181008	50.0 mm	2,561 mm ²	90	60	35	M8, M10, M12	–	130 N

Non-continuous supports may not exceed spacing of 5' (1.5 m) per TIA 569-C.9.7 and EN 50174-2.
Cable capacity is calculated based on a 70% fill rate.

CADDY® CAT HP J-Hook with Pin Driven Angle Bracket

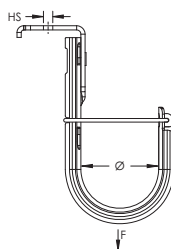

- Longer leg angle bracket for tool clearance
- Designed to fit a variety of pin drivers
- Rotates to support various directional runs of cable
- Provides optimal support for high-performance data cable, up to and including Cat 5e, Cat 6, Cat 6A, Cat 7 and fibre optic
- Provides superior fill capacity and load rating over most other non-continuous cable support alternatives
- Rounded edges on J-Hooks provide proper bend radius support for high performance data cables
- Cost effective alternative to expensive cable tray
- Complies with EN 50174-2
- Meets ISO/IECSM 14763-2, TIA 568-C and TIA 569-C

Material: Steel

Finish: Pre-galvanized



Part Number	Article Number	Diameter Ø	Area	Cable Capacity, Cat 5e	Cable Capacity, Cat 6	Cable Capacity, Cat 6A	Hole Size HS	Static Load F
CAT16HPAFAB3	181009	25.0 mm	690 mm ²	20	15	10	4 mm	270 N
CAT21HPAFAB3	181191	33.3 mm	1,174 mm ²	50	40	25	4 mm	270 N
CAT21HPAFAB4	181192	33.3 mm	1,174 mm ²	50	40	25	6 mm	270 N
CAT21HPAFAB6	181193	33.3 mm	1,174 mm ²	50	40	25	9 mm	270 N
CAT32HPAFAB3	181011	50.0 mm	2,561 mm ²	90	60	35	4 mm	270 N
CAT32HPAFAB4	181012	50.0 mm	2,561 mm ²	90	60	35	6 mm	270 N
CAT32HPAFAB6	181013	50.0 mm	2,561 mm ²	90	60	35	9 mm	270 N
CAT48HPAFAB3	181233	75.0 mm	5,974 mm ²	200	150	80	4 mm	270 N
CAT48HPAFAB4	181234	75.0 mm	5,974 mm ²	200	150	80	6 mm	270 N
CAT48HPAFAB6	181235	75.0 mm	5,974 mm ²	200	150	80	9 mm	270 N
CAT64HPAFAB3	181223	100.0 mm	9,987 mm ²	330	220	140	4 mm	270 N
CAT64HPAFAB4	181224	100.0 mm	9,987 mm ²	330	220	140	6 mm	270 N
CAT64HPAFAB6	181225	100.0 mm	9,987 mm ²	330	220	140	9 mm	270 N

Non-continuous supports may not exceed spacing of 5' (1.5 m) per TIA 569-C.9.7.

Cable capacity is calculated based on a 70% fill rate.

CADDY® CAT HP ASSEMBLIES



CADDY® CAT HP J-Hook with Angle Bracket

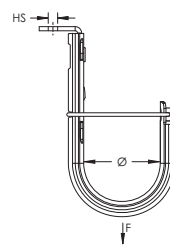

- Ideal for attaching to concrete, steel or wood surfaces
- Provides optimal support for high-performance data cable, up to and including Cat 5e, Cat 6, Cat 6A, Cat 7 and fibre optic
- Provides superior fill capacity and load rating over most other non-continuous cable support alternatives
- Rounded edges on J-Hooks provide proper bend radius support for high performance data cables
- Cost effective alternative to expensive cable tray
- Complies with EN 50174-2
- Meets ISO/IECSM 14763-2, TIA 568-C and TIA 569-C

Material: Steel

Finish: Pre-galvanized



Part Number	Article Number	Diameter Ø	Area	Cable Capacity, Cat 5e	Cable Capacity, Cat 6	Cable Capacity, Cat 6A	Hole Size HS	Static Load F
CAT16HPAB	181209	25.0 mm	690 mm ²	20	15	10	6.3 mm	270 N
CAT21HPAB	181189	33.3 mm	1,174 mm ²	50	40	25	6.3 mm	270 N
CAT32HPAB	181211	50.0 mm	2,561 mm ²	90	60	35	6.3 mm	270 N
CAT48HPAB	181212	75.0 mm	5,974 mm ²	200	150	80	6.3 mm	270 N
CAT64HPAB	181024	100.0 mm	9,987 mm ²	330	220	140	6.3 mm	270 N

Non-continuous supports may not exceed spacing of 5' (1.5 m) per TIA 569-C.9.7.

Cable capacity is calculated based on a 70% fill rate.

CADDY® CAT HP J-Hook with Strut Attachment Clip

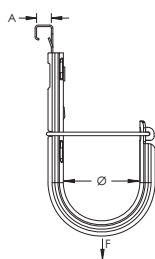

- Attaches to open side of a strut channel
- Provides optimal support for high-performance data cable, up to and including Cat 5e, Cat 6, Cat 6A, Cat 7 and fibre optic
- Provides superior fill capacity and load rating over most other non-continuous cable support alternatives
- Cost effective alternative to expensive cable tray
- Complies with EN 50174-2
- Meets ISO/IECSM 14763-2, TIA 568-C and TIA 569-C

Material: Steel, Spring Steel

Finish: Pre-galvanized, CADDY® ARMOUR



Part Number	Article Number	Diameter Ø	Area	Cable Capacity, Cat 5e	Cable Capacity, Cat 6	Cable Capacity, Cat 6A	A	Static Load F
CAT16HPESC	181022	25.0 mm	690 mm ²	20	15	10	9.9 mm	270 N
CAT21HPESC	181261	33.3 mm	1,174 mm ²	50	40	25	9.9 mm	270 N
CAT32HPESC	181023	50.0 mm	2,561 mm ²	90	60	35	9.9 mm	270 N

Non-continuous supports may not exceed spacing of 5' (1.5 m) per TIA 569-C.9.7 and EN 50174-2.

Cable capacity is calculated based on a 70% fill rate.

CADDY® CAT HP J-Hook with Pedestal Clamp

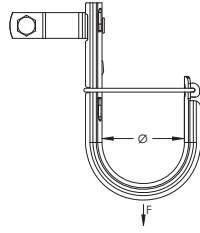

- Easy installation to pedestals used under raised floors
- Provides optimal support for high-performance data cable, up to and including Cat 5e, Cat 6, Cat 6A, Cat 7 and fibre optic
- Provides superior fill capacity and load rating over most other non-continuous cable support alternatives
- Cost effective alternative to expensive cable tray
- Complies with EN 50174-2
- Meets ISO/IECSM 14763-2, TIA 568-C and TIA 569-C

Material: Steel

Finish: Pre-galvanized

Pedestal Size: 19 mm Square, 22.2 - 28.5 mm Round



Part Number	Article Number	Diameter Ø	Area	Cable Capacity, Cat 5e	Cable Capacity, Cat 6	Cable Capacity, Cat 6A	Static Load F
CAT16HPCD1B	181226	25.0 mm	690 mm ²	20	15	10	270 N
CAT21HPCD1B	181247	33.3 mm	1,174 mm ²	50	40	25	270 N
CAT32HPCD1B	181227	50.0 mm	2,561 mm ²	90	60	35	270 N
CAT48HPCD1B	181228	75.0 mm	5,974 mm ²	200	150	80	270 N
CAT64HPCD1B	181229	100.0 mm	9,987 mm ²	330	220	140	270 N

Non-continuous supports may not exceed spacing of 5' (1.5 m) per TIA 569-C.9.7 and EN 50174-2.

Cable capacity is calculated based on a 70% fill rate.

CADDY® CAT HP ASSEMBLIES

CADDY® CAT HP J-Hook with T-Grid Clip

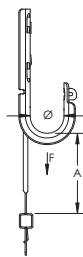

- No installation tools required for basic clip
- Provides optimal support for high-performance data cable, up to and including Cat 5e, Cat 6, Cat 6A, Cat 7 and fibre optic
- Provides superior fill capacity and load rating over most other non-continuous cable support alternatives
- Rounded edges on J-Hooks provide proper bend radius support for high performance data cables
- Cost effective alternative to expensive cable tray
- Complies with EN 50174-2
- Meets ISO/IECSM 14763-2, TIA 568-C and TIA 569-C

Material: Steel, Spring Steel

Finish: CADDY® ARMOUR, Pre-galvanized



Part Number	Article Number	Diameter Ø	Area	Cable Capacity, Cat 5e	Cable Capacity, Cat 6	Cable Capacity, Cat 6A	A	Static Load F
CAT16HPTS	181089	25.0 mm	690 mm ²	20	15	10	65 mm	270 N

Additional support wire required per NEC[®] 300.11.

Non-continuous supports may not exceed spacing of 5' (1.5 m) per TIA 569-C.9.7 and EN 50174-2.

Cable capacity is calculated based on a 70% fill rate.



CADDY® CAT HP J-Hook Trees



CADDY® CAT HP J-Hook Trees are the ideal solution for segregating multiple runs of cable following the same path. They are ready to use right out of the box with a broad range of sizes and attachment methods.

- Provides optimal support for high-performance data cable, up to and including Cat 5e, Cat 6, Cat 6A, Cat 7 and fibre optic
- Ready to use out of the box, saving installation time and labor
- Requires no screws, rivets or special tools for assembly
- Single- or double-sided tree configurations provide multiple J-Hooks with one structural attachment
- Provides superior fill capacity and load rating over most other non-continuous cable support alternatives
- Meets ISO/IECSM 14763-2, TIA 568-C and TIA 569-C



CADDY® CAT HP J-Hook Tree, Ceiling Mount



CADDY® CAT HP J-Hook Tree, Flange Mount



CADDY® CAT HP J-Hook Tree, Wall Mount

CADDY® CAT HP J-Hook Tree, Ceiling Mount



- Ideal for attaching to concrete, steel or wood surfaces
- Provides optimal support for high-performance data cable, up to and including Cat 5e, Cat 6, Cat 6A, Cat 7 and fibre optic
- Ready to use out of the box, saving installation time and labor
- Requires no screws, rivets or special tools for assembly
- Single- or double-sided tree configurations provide multiple J-Hooks with one structural attachment
- Provides superior fill capacity and load rating over most other non-continuous cable support alternatives
- Complies with EN 50174-2
- Meets ISO/IECSM 14763-2, TIA 568-C and TIA 569-C

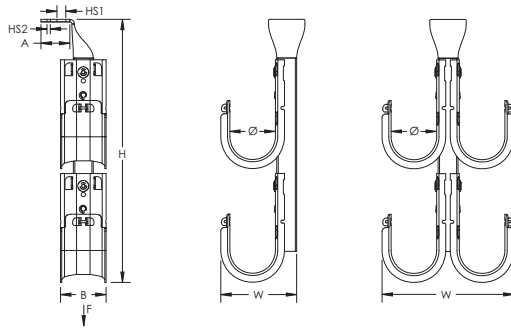

Material: Steel
Finish: Pre-galvanized



Part Number	Article Number	Diameter Ø	Tiers	Height H	Width W	Hole Size 1 HS1	Hole Size 2 HS2	A	B	Static Load 1 F1	Static Load 2 F2
Type: Single Sided											
CAT32HPSCM2	181046	50 mm	2	260 mm	148.0 mm	10.3 mm	4.7 mm	36.5 mm	50 mm	1,080 N	810 N
CAT32HPSCM3	181047	50 mm	3	387 mm	148.0 mm	10.3 mm	4.7 mm	36.5 mm	50 mm	1,620 N	810 N
CAT32HPSCM4	181048	50 mm	4	514 mm	148.0 mm	10.3 mm	4.7 mm	36.5 mm	50 mm	2,160 N	810 N
CAT64HPSCM2	181053	100 mm	2	387 mm	254.0 mm	10.3 mm	4.7 mm	36.5 mm	50 mm	1,080 N	810 N
CAT64HPSCM3	181054	100 mm	3	578 mm	254.0 mm	10.3 mm	4.7 mm	36.5 mm	50 mm	1,620 N	810 N
CAT64HPSCM4	181056	100 mm	4	768 mm	254.0 mm	10.3 mm	4.7 mm	36.5 mm	50 mm	2,160 N	810 N
Type: Double Sided											
CAT32HPDCM2	181049	50 mm	2	260 mm	148.0 mm	10.3 mm	4.7 mm	36.5 mm	50 mm	1,080 N	810 N
CAT32HPDCM3	181051	50 mm	3	387 mm	148.0 mm	10.3 mm	4.7 mm	36.5 mm	50 mm	1,620 N	810 N
CAT32HPDCM4	181052	50 mm	4	514 mm	148.0 mm	10.3 mm	4.7 mm	36.5 mm	50 mm	2,160 N	810 N
CAT64HPDCM2	181057	100 mm	2	387 mm	254.0 mm	10.3 mm	4.7 mm	36.5 mm	50 mm	1,080 N	810 N
CAT64HPDCM3	181058	100 mm	3	578 mm	254.0 mm	10.3 mm	4.7 mm	36.5 mm	50 mm	1,620 N	810 N
CAT64HPDCM4	181059	100 mm	4	768 mm	254.0 mm	10.3 mm	4.7 mm	36.5 mm	50 mm	2,160 N	810 N

Static loads represent maximum load limit of J-Hook tree. Static load limit of each J-Hook is 60 lb (270 N). Refer to Static Load 1 when fastening J-Hook tree using Hole Size 1. Refer to Static Load 2 when fastening J-Hook tree using Hole Size 2. Non-continuous supports may not exceed spacing of 5' (1.5 m) per TIA 569-C.9.7 and EN 50174-2.

CADDY® CAT HP J-HOOK TREES



CADDY® CAT HP J-Hook Tree, Flange Mount



- Easy installation to beam flanges
- Provides optimal support for high-performance data cable, up to and including Cat 5e, Cat 6, Cat 6A, Cat 7 and fibre optic
- Ready to use out of the box, saving installation time and labor
- Requires no screws, rivets or special tools for assembly
- Single- or double-sided tree configurations provide multiple J-Hooks with one structural attachment
- Provides superior fill capacity and load rating over most other non-continuous cable support alternatives
- Complies with EN 50174-2
- Meets ISO/IECSM 14763-2, TIA 568-C and TIA 569-C

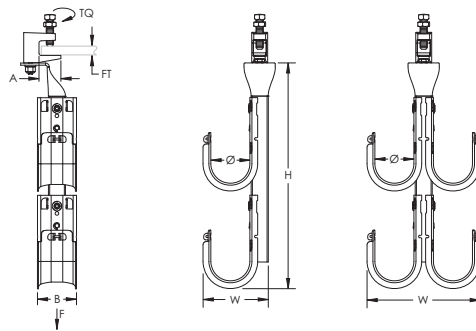

Material: Steel
Finish: Pre-galvanized



Part Number	Article Number	Diameter Ø	Tiers	Flange Thickness FT	Height H	Width W	A	B	Torque TQ	Static Load F
Type: Single Sided										
CAT32HPSFM2	181033	50 mm	2	20.6 mm Max	260 mm	84.8 mm	28.5 mm	50 mm	7 N-m	530 N
CAT32HPSFM3	181034	50 mm	3	20.6 mm Max	387 mm	84.8 mm	28.5 mm	50 mm	7 N-m	800 N
CAT32HPSFM4	181035	50 mm	4	20.6 mm Max	514 mm	84.8 mm	28.5 mm	50 mm	7 N-m	1,060 N
CAT64HPSFM2	181039	100 mm	2	20.6 mm Max	387 mm	138.0 mm	28.5 mm	50 mm	7 N-m	530 N
CAT64HPSFM3	181041	100 mm	3	20.6 mm Max	578 mm	138.0 mm	28.5 mm	50 mm	7 N-m	800 N
CAT64HPSFM4	181042	100 mm	4	20.6 mm Max	768 mm	138.0 mm	28.5 mm	50 mm	7 N-m	1,060 N
Type: Double Sided										
CAT32HPDFM2	181036	50 mm	2	20.6 mm Max	260 mm	148.0 mm	3.2 mm	50 mm	7 N-m	1,060 N
CAT32HPDFM3	181037	50 mm	3	20.6 mm Max	387 mm	148.0 mm	3.2 mm	50 mm	11 N-m	1,600 N
CAT32HPDFM4	181038	50 mm	4	20.6 mm Max	514 mm	148.0 mm	3.2 mm	50 mm	11 N-m	2,130 N
CAT64HPDFM2	181043	100 mm	2	20.6 mm Max	387 mm	254.0 mm	3.2 mm	50 mm	7 N-m	1,060 N
CAT64HPDFM3	181044	100 mm	3	20.6 mm Max	578 mm	254.0 mm	3.2 mm	50 mm	11 N-m	1,600 N
CAT64HPDFM4	181045	100 mm	4	20.6 mm Max	768 mm	254.0 mm	3.2 mm	50 mm	11 N-m	2,130 N

Static loads represent maximum load limit of J-Hook tree. Static load limit of each J-Hook is 60 lb (270 N).

Setscrew must be tightened and torqued onto the sloped side of the I-beam.

Non-continuous supports may not exceed spacing of 5' (1.5 m) per TIA 569-C.9.7 and EN 50174-2.

Recognizing that torque wrenches are generally not used or available on many job sites, the setscrew should be tightened so it contacts the I-beam and then an additional 1/4 to 1/2 turn added.

CADDY® CAT HP J-HOOK TREES

CADDY® CAT HP J-Hook Tree, Wall Mount



- Ideal for attaching to concrete, steel or wood surfaces
- Provides optimal support for high-performance data cable, up to and including Cat 5e, Cat 6, Cat 6A, Cat 7 and fibre optic
- Ready to use out of the box, saving installation time and labor
- Requires no screws, rivets or special tools for assembly
- Provides superior fill capacity and load rating over most other non-continuous cable support alternatives
- Complies with EN 50174-2
- Meets ISO®/IECSM 14763-2, TIA 568-C and TIA 569-C

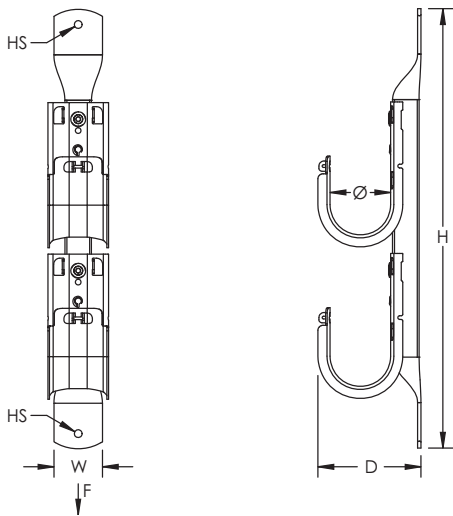

Material: Steel
 Finish: Pre-galvanized
 Type: Single Sided



Part Number	Article Number	Diameter Ø	Tiers	Height H	Depth D	Width W	Hole Size HS	Static Load F
CAT32HPSWM2	181026	50 mm	2	368.3 mm	86.4 mm	50 mm	6.5 mm	530 N
CAT32HPSWM3	181027	50 mm	3	495.3 mm	86.4 mm	50 mm	6.5 mm	800 N
CAT32HPSWM4	181028	50 mm	4	622.3 mm	86.4 mm	50 mm	6.5 mm	1,060 N
CAT64HPSWM2	181029	100 mm	2	495.3 mm	139.7 mm	50 mm	6.5 mm	530 N
CAT64HPSWM3	181031	100 mm	3	685.8 mm	139.7 mm	50 mm	6.5 mm	800 N
CAT64HPSWM4	181032	100 mm	4	876.3 mm	139.7 mm	50 mm	6.5 mm	1,060 N

Static loads represent maximum load limit of J-Hook tree. Static load limit of each J-Hook is 60 lb (270 N).
 Non-continuous supports may not exceed spacing of 5' (1.5 m) per TIA 569-C.9.7 and EN 50174-2.

CADDY® CAT HP J-HOOK TREES



CADDY® CAT HP Components



CADDY® CAT HP components offer a high-performance J-Hook solution with interchangeable fasteners and support brackets. The components can be used to link together multiple J-Hooks to meet specific jobsite cable support requirements. CADDY CAT HP components are ideal for projects that require flexibility to adapt cable pathways or avoid other building services or structures on the jobsite, or when it is necessary to add additional cable support pathways. The system is quick to install, easy to use and compatible with a wide variety of CADDY® fasteners.

- Available with a wide range of fastener, fixing, and support brackets
- Requires no screws, rivets or special tools for assembly
- J-Hooks feature bendable locking tabs that lock on to CADDY® CAT HP components to provide rigidity and stability
- Link to J-Hooks in one of multiple color options to aid in pathway identification and organization
- Customized J-Hook trees can be easily assembled with various J-Hook sizes, colors and configurations



CADDY® CAT HP
J- Hook Clip to Flange



CADDY® CAT HP
J-Hook Clip to Purlin



CADDY® CAT HP
J-Hook Clip to Rod/Wire



CADDY® CAT HP
J-Hook Clip to Strut



CADDY® CAT HP
J-Hook Clip to Pedestal



CADDY® CAT HP Brackets

CADDY® CAT HP J-Hook Clip to BC200 Beam Clamp

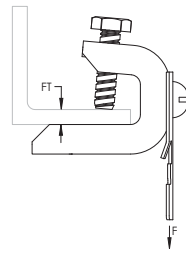

- Easy installation to beam flanges
- Requires no screws, rivets or special tools for assembly
- J-Hooks feature bendable locking tabs that lock on to CADDY® CAT HP components to provide rigidity and stability
- Link to J-Hooks in one of multiple color options to aid in pathway identification and organization
- Customized J-Hook trees can be easily assembled with various J-Hook sizes, colors and configurations
- CADDY® CAT HP components easily attach to any size CADDY CAT HP J-Hook

Orientation: Side Mount

Material: Steel, Spring Steel

Finish: Electro-galvanized, CADDY® ARMOUR



Part Number	Article Number	Flange Thickness FT	Static Load F
CATHPBC200	181079	16 mm Max	445 N

CADDY® CAT HP J-Hook Clip to BC200 Beam Clamp, Swivel

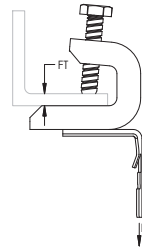

- Easy installation to beam flanges
- Rotates to support various directional runs of cable
- Requires no screws, rivets or special tools for assembly
- J-Hooks feature bendable locking tabs that lock on to CADDY® CAT HP components to provide rigidity and stability
- Link to J-Hooks in one of multiple color options to aid in pathway identification and organization
- Customized J-Hook trees can be easily assembled with various J-Hook sizes, colors and configurations
- CADDY® CAT HP components easily attach to any size CADDY CAT HP J-Hook

Orientation: Bottom Mount

Material: Steel, Spring Steel

Finish: Electro-galvanized, CADDY® ARMOUR



Part Number	Article Number	Flange Thickness FT	Static Load F
CATHPBC200B	181074	16 mm Max	445 N



CADDY® CAT HP J-Hook Clip to Hammer-On Flange Clip

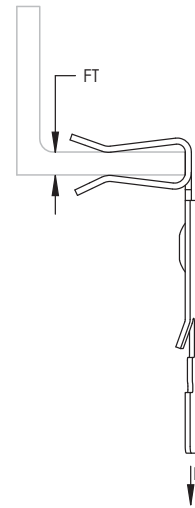

- Requires only a hammer to install
- Requires no screws, rivets or special tools for assembly
- J-Hooks feature bendable locking tabs that lock on to CADDY® CAT HP components to provide rigidity and stability
- Link to J-Hooks in one of multiple color options to aid in pathway identification and organization
- Customized J-Hook trees can be easily assembled with various J-Hook sizes, colors and configurations
- CADDY® CAT HP components easily attach to any size CADDY CAT HP J-Hook

Orientation: Side Mount
 Material: Spring Steel
 Finish: CADDY® ARMOUR



Part Number	Article Number	Flange Thickness FT	Static Load F
CATHP24SM	181075	3 – 8 mm	890 N
CATHP58SM	181076	8 – 14 mm	890 N
CATHP912SM	181077	14 – 20 mm	890 N

CADDY® CAT HP J-Hook Clip to Hammer-On Flange Clip, Swivel

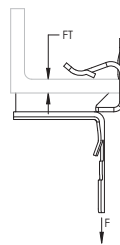

- Requires only a hammer to install
- Rotates to support various directional runs of cable
- Requires no screws, rivets or special tools for assembly
- J-Hooks feature bendable locking tabs that lock on to CADDY® CAT HP components to provide rigidity and stability
- Link to J-Hooks in one of multiple color options to aid in pathway identification and organization
- Customized J-Hook trees can be easily assembled with various J-Hook sizes, colors and configurations
- CADDY® CAT HP components easily attach to any size CADDY CAT HP J-Hook

Orientation: Bottom Mount
 Material: Spring Steel
 Finish: CADDY® ARMOUR



Part Number	Article Number	Flange Thickness FT	Static Load F
CATHP24	181091	3 – 8 mm	334 N
CATHP58	181071	8 – 14 mm	334 N
CATHP912	181072	14 – 20 mm	334 N

CADDY® CAT HP J-Hook Clip to BC Beam Clamp

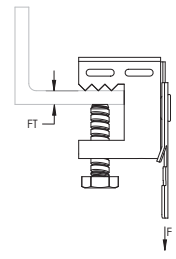
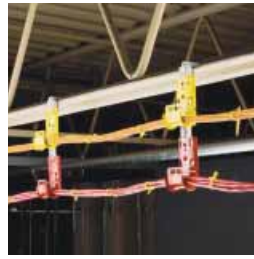

- Easy installation to beam flanges
- Requires no screws, rivets or special tools for assembly
- J-Hooks feature bendable locking tabs that lock on to CADDY® CAT HP components to provide rigidity and stability
- Link to J-Hooks in one of multiple color options to aid in pathway identification and organization
- Customized J-Hook trees can be easily assembled with various J-Hook sizes, colors and configurations
- CADDY® CAT HP components easily attach to any size CADDY CAT HP J-Hook

Orientation: Side Mount

Material: Steel, Spring Steel

Finish: Electro-galvanized, CADDY® ARMOUR



Part Number	Article Number	Flange Thickness FT	Static Load F
CATHPBC	181078	16 mm Max	445 N

CADDY® CAT HP J-Hook Clip to BC Beam Clamp, Swivel

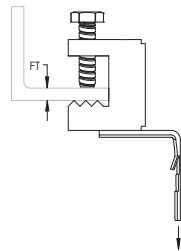

- Easy installation to beam flanges
- Rotates to support various directional runs of cable
- Requires no screws, rivets or special tools for assembly
- J-Hooks feature bendable locking tabs that lock on to CADDY® CAT HP components to provide rigidity and stability
- Link to J-Hooks in one of multiple color options to aid in pathway identification and organization
- Customized J-Hook trees can be easily assembled with various J-Hook sizes, colors and configurations
- CADDY® CAT HP components easily attach to any size CADDY CAT HP J-Hook

Orientation: Bottom Mount

Material: Steel, Spring Steel

Finish: Electro-galvanized, CADDY® ARMOUR



Part Number	Article Number	Flange Thickness FT	Static Load F
CATHPBCB	181073	16 mm Max	267 N

CADDY® CAT HP COMPONENTS



CADDY® CAT HP J-Hook Clip to C Purlin Clip

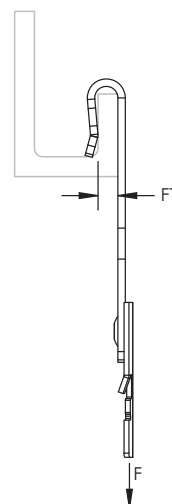

- Hammer-on or install from the floor with the VAFT tool
- Requires no screws, rivets or special tools for assembly
- J-Hooks feature bendable locking tabs that lock on to CADDY® CAT HP components to provide rigidity and stability
- Link to J-Hooks in one of multiple color options to aid in pathway identification and organization
- Customized J-Hook trees can be easily assembled with various J-Hook sizes, colors and configurations
- CADDY® CAT HP components easily attach to any size CADDY CAT HP J-Hook

Material: Spring Steel
Finish: CADDY® ARMOUR



Part Number	Article Number	Flange Thickness FT	Static Load F
CATHPVF14	181081	1.5 – 6.0 mm	712 N

CADDY® CAT HP J-Hook Clip to Z Purlin Clip

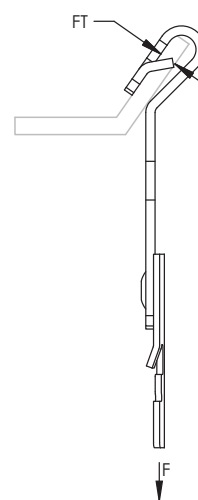

- Requires only a hammer to install
- Requires no screws, rivets or special tools for assembly
- J-Hooks feature bendable locking tabs that lock on to CADDY® CAT HP components to provide rigidity and stability
- Link to J-Hooks in one of multiple color options to aid in pathway identification and organization
- Customized J-Hook trees can be easily assembled with various J-Hook sizes, colors and configurations
- CADDY® CAT HP components easily attach to any size CADDY CAT HP J-Hook

Material: Spring Steel
Finish: CADDY® ARMOUR



Part Number	Article Number	Flange Thickness FT	Static Load F
CATHPAF14	181092	1.5 – 6.0 mm	445 N

CADDY® CAT HP J-Hook Clip to Rod/Wire Clip

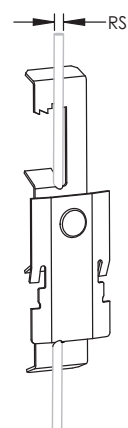

- Quick attachment to threaded rod or wire
- Requires no screws, rivets or special tools for assembly
- J-Hooks feature bendable locking tabs that lock on to CADDY® CAT HP components to provide rigidity and stability
- Link to J-Hooks in one of multiple color options to aid in pathway identification and organization
- Customized J-Hook trees can be easily assembled with various J-Hook sizes, colors and configurations
- CADDY® CAT HP components easily attach to any size CADDY CAT HP J-Hook

Material: Spring Steel
Finish: CADDY® ARMOUR



Part Number	Article Number	Rod Size RS	Wire Size	Static Load F
CATHP4Z34	181083	M4, M6, M8	4.8 – 6.4 mm	130 N
CATHP6Z34	181084	M8, M10, M12	–	130 N

Recommended for use with CADDY® CAT HP J-Hooks with a diameter of 2" (50 mm) or less.

CADDY® CAT HP J-Hook Clip to Strut Clip

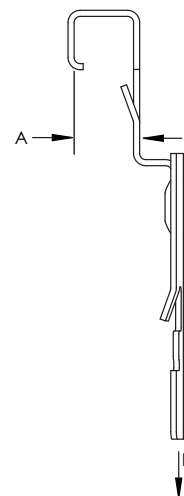

- Easily attaches to the side of strut
- Requires no screws, rivets or special tools for assembly
- J-Hooks feature bendable locking tabs that lock on to CADDY® CAT HP components to provide rigidity and stability
- Link to J-Hooks in one of multiple color options to aid in pathway identification and organization
- Customized J-Hook trees can be easily assembled with various J-Hook sizes, colors and configurations
- CADDY® CAT HP components easily attach to any size CADDY CAT HP J-Hook

Material: Spring Steel
Finish: CADDY® ARMOUR



Part Number	Article Number	A	Static Load F
CATHPESC	181082	9.9 mm	445 N



CADDY® CAT HP J-Hook Clip to Pedestal Clamp



- Easy installation to pedestals used under raised floors
- Requires no screws, rivets or special tools for assembly
- J-Hooks feature bendable locking tabs that lock on to CADDY® CAT HP components to provide rigidity and stability
- Link to J-Hooks in one of multiple color options to aid in pathway identification and organization
- Customized J-Hook trees can be easily assembled with various J-Hook sizes, colors and configurations
- CADDY® CAT HP components easily attach to any size CADDY CAT HP J-Hook

Material: Steel, Spring Steel

Finish: Electro-galvanized, CADDY® ARMOUR



Part Number	Article Number	Pedestal Size	Static Load
CATHPCD0B	181085	19 mm Round	70 N
CATHPCD1B	181086	19 mm Square, 22.2 - 28.5 mm Round	70 N
CATHPCD2B	181088	22.2 mm Square	70 N
CATHPCD2.5B	181087	22.2 mm Square	70 N

CADDY® CAT HP J-Hook Angle Bracket

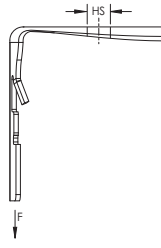

- Ideal for attaching to concrete, steel or wood surfaces
- Requires no screws, rivets or special tools for assembly
- J-Hooks feature bendable locking tabs that lock on to CADDY® CAT HP components to provide rigidity and stability
- Link to J-Hooks in one of multiple color options to aid in pathway identification and organization
- Customized J-Hook trees can be easily assembled with various J-Hook sizes, colors and configurations
- CADDY® CAT HP components easily attach to any size CADDY CAT HP J-Hook

Material: Spring Steel
Finish: CADDY® ARMOUR



Part Number	Article Number	Hole Size HS	Static Load F
CATHPAN	181065	4.7 mm	712 N
CATHPA4	181066	7.2 mm	667 N
CATHPA6	181067	10.4 mm	890 N

CADDY® CAT HP J-Hook Straight Bracket

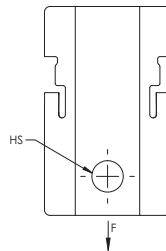

- Can be attached to various CADDY® fasteners or screwed directly to a wall
- Ideal for attaching to concrete, steel or wood surfaces
- Requires no screws, rivets or special tools for assembly
- J-Hooks feature bendable locking tabs that lock on to CADDY® CAT HP components to provide rigidity and stability
- Link to J-Hooks in one of multiple color options to aid in pathway identification and organization
- Customized J-Hook trees can be easily assembled with various J-Hook sizes, colors and configurations
- CADDY® CAT HP components easily attach to any size CADDY CAT HP J-Hook

Material: Spring Steel
Finish: CADDY® ARMOUR



Part Number	Article Number	Hole Size HS	Static Load F
CATHPS4	181068	7 mm	890 N



CADDY® CAT HP J-Hook Tree Mount Bracket



- Requires no screws, rivets or special tools for assembly
- J-Hooks feature bendable locking tabs that lock on to CADDY® CAT HP components to provide rigidity and stability
- Link to J-Hooks in one of multiple color options to aid in pathway identification and organization
- Customized J-Hook trees can be easily assembled with various J-Hook sizes, colors and configurations
- CADDY® CAT HP components easily attach to any size CADDY CAT HP J-Hook

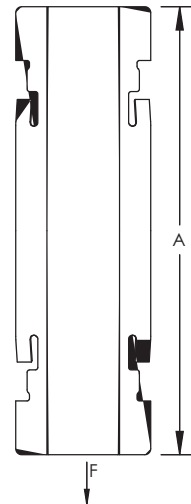

Material: Spring Steel
Finish: CADDY® ARMOUR

Part Number	Article Number	A	Static Load F
CATHPTM	181069	111 mm	890 N

CADDY® CAT HP Accessories

CADDY® CAT HP ACCESSORIES



CADDY® CAT
HP Cable Puller Kit



CADDY® CAT
HP Wire Retainer

CADDY® CAT HP Cable Puller Kit



- Minimizes pulling tension per TIA 568-C.5.3.1 during the installation of high-performance data cables
- Includes retainer, screw, angle bracket, tree mount bracket, carabiner hook and beam clamp

Material: Steel

Finish: Pre-galvanized

Part Number	Article Number	Diameter
CATHPLR	181093	50 mm



CADDY® CAT HP Wire Retainer



- Replacement wire retainer for CADDY® CAT HP J-Hooks
- Provides 360 degree containment for cables

Material: Steel

Finish: Pre-galvanized

Part Number	Article Number	Description
RET16B50	181271	CADDY® CAT HP Wire Retainer for 25.0 mm Diameter J-Hooks
RET21B50	181272	CADDY® CAT HP Wire Retainer for 33.3 mm Diameter J-Hooks
RET32B50	181273	CADDY® CAT HP Wire Retainer for 50.0 mm Diameter J-Hooks
RET48B25	181274	CADDY® CAT HP Wire Retainer for 75.0 mm Diameter J-Hooks
RET64B25	181275	CADDY® CAT HP Wire Retainer for 100.0 mm Diameter J-Hooks

CADDY® CAT CM Cable Support System



The CADDY® CAT CM Cable Support System offers an ideal cable management solution for retrofit and new construction applications. The system provides the ability to handle significant volumes of cable with greater flexibility and often more economically than traditional cable tray solutions. In retrofit applications, CADDY CAT CM Cable Supports provide the ability to route large quantities of cable around existing infrastructure and other trades. In addition, CADDY CAT CM solutions can be installed below existing cable management systems to add additional capacity to existing runs, or against the ceiling for a low-profile solution.

- Provides optimal support for high-performance data cable, up to and including Cat 5e, Cat 6, Cat 6A, Cat 7 and fibre optic
- Specially designed U-Hooks and double J-Hook have large-diameter, rounded support surfaces
- Rounded edges help prevent over-bending and kinking of cables
- System offers a convenient pathway for wires and cables
- Provides superior installation flexibility with strut, rod and cantilever mounting installation options
- Compliant with NEC® and ANSI/TIA structured cabling systems standards

CADDY® CAT CM CABLE SUPPORT SYSTEM

PAGE 39



CADDY® CAT CM
U-Hook, Strut Mount

PAGE 40



CADDY® CAT
CM Double J-Hook

PAGE 40



CADDY® CAT CM Roller

PAGE 41



CADDY® CAT
CM Wire Retainer

PAGE 41



CADDY® CAT
CM Protection Tube

PAGE 41



CADDY® CAT
CM Wall Bracket



CADDY® CAT CM U-Hook, Strut Mount

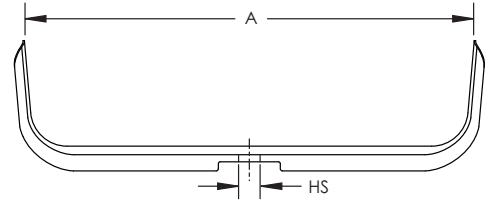

- Provides optimal support for high-performance data cable, up to and including Cat 5e, Cat 6, Cat 6A, Cat 7 and fibre optic
- Integrated quick-attach T-nut allows U-Hooks to be quickly mounted to strut
- System offers a convenient pathway for wires and cables
- Specially designed U-Hooks have large-diameter, rounded support surfaces
- Rounded edges help prevent over-bending and kinking of cables
- Ideal for retrofit applications where cable runs need to be routed around existing building infrastructure
- Compliant with NEC® and ANSI/TIA structured cabling systems standards

Material: Steel

Finish: Electro-galvanized

Included Components: Quick-Attach T-Nut



Part Number	Article Number	Cable Capacity, Cat 5e	Cable Capacity, Cat 6	A	Area	Hole Size HS	Static Load F
CAT200CM	181982	500	315	203 mm	533 mm ²	9.5 mm	440 N
CAT300CM	181984	750	470	304 mm	812 mm ²	9.5 mm	440 N

CADDY® CAT CM Double J-Hook

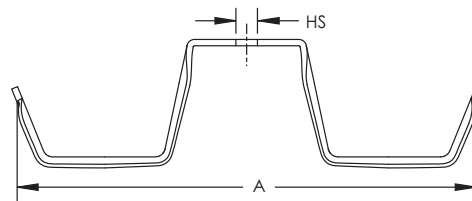

- Provides optimal support for high-performance data cable, up to and including Cat 5e, Cat 6, Cat 6A, Cat 7 and fibre optic
- System offers a convenient pathway for wires and cables
- Allows addition of cables even when fixed flush to overhead decking
- Specially designed double J-Hook has large-diameter, rounded support surfaces
- Rounded edges help prevent over-bending and kinking of cables
- Ideal for retrofit applications where cable runs need to be routed around existing building infrastructure
- Compliant with NEC® and ANSI/TIA structured cabling systems standards

Material: Steel

Finish: Electro-galvanized



Part Number	Article Number	Cable Capacity, Cat 5e	Cable Capacity, Cat 6	A	Area	Hole Size HS	Certifications
CAT100CM	181976	80	50	185 mm	80 mm ²	9.5 mm	cULus

Area shown is the combined value for both sides. Divide by 2 for area of each side.

CADDY® CAT CM Roller

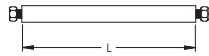

- Retains cables while supporting cable pulls

Material: Steel
Finish: Pre-galvanized

Part Number	Article Number	Length L
CATRL200CM	181988	200 mm
CATRL300CM	181989	300 mm

CADDY® CAT CM CABLE SUPPORT SYSTEM

CADDY® CAT CM Wire Retainer



- Provides 360 degree containment for cables

Material: Steel
Finish: Pre-galvanized

Part Number	Article Number	Wire Size	Length L
CATRT200CM	181991	5.4 mm	254 mm
CATRT300CM	181992	5.4 mm	342 mm



CADDY® CAT CM Protection Tube

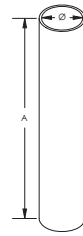

- Protects high performance data cables from coming in contact with threaded rod
- Minimizes the risk of cutting or abrading cable sheaths while pulling cable

Material: Steel

Finish: Electro-galvanized

Part Number	Article Number	Diameter Ø	A
CATTBCM	181987	17 mm	100 mm

CADDY® CAT 425 Adjustable Cable Supports



CADDY® CAT 425 Adjustable Cable Supports provide an ideal solution for retrofit applications in existing facilities where space is limited and cable tray would be very difficult to install. The system supports a large quantity of cable, and can be mounted to overhead building structure or wall-mounted for low-profile installations. The fabric is strong yet flexible, and is suitable for pulling cable.

- Provides optimal support for high-performance data cable, up to and including Cat 5e, Cat 6, Cat 6A, Cat 7 and fibre optic
- Multiple sizes and designs available to attach to a variety of structures

PAGE 43



CADDY® CAT 425
Adjustable Cable Support

PAGE 43



CADDY® CAT 425
Wall Mount Adjustable
Cable Support

PAGE 44



CADDY® CAT 425
Adjustable Cable Support
with BC Beam Clamp

PAGE 44



CADDY® CAT 425
Adjustable Cable Support
with BC200 Beam Clamp

PAGE 45



CADDY® CAT 425
Adjustable Cable
Support with Flange Clip

PAGE 45



CADDY® CAT 425
Adjustable Cable Support
with C Purlin Clip

PAGE 46



CADDY® CAT 425
Adjustable Cable Support
with Z Purlin Clip

PAGE 46



CADDY® CAT 425
Adjustable Cable Support
with Pedestal Clamp

CADDY® CAT 425 ADJUSTABLE CABLE SUPPORTS



CADDY® CAT 425 Adjustable Cable Support



- Provides optimal support for high-performance data cable, up to and including Cat 5e, Cat 6, Cat 6A, Cat 7 and fibre optic
- Simple unlocking and locking of bar allows for additional cables to be added easily after installation
- Adjustable strap allows for multiple support sizes to reduce inventory
- Cost effective alternative to expensive cable tray
- cULus® Listed and complies with NEC® and TIA requirements for structured cabling systems
- Suitable for air handling spaces (plenum)

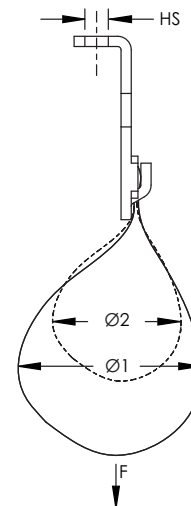

Material: Polyethylene, Steel
Finish: Electro-galvanized



Part Number	Article Number	Area	Cable Capacity, Cat 5e	Cable Capacity, Cat 6	Diameter 1 Ø1	Diameter 2 Ø2	Hole Size HS	Static Load F
CAT425	181130	518 mm ²	425	265	150 mm	100 mm	7 mm	450 N

CADDY® CAT 425 Wall Mount Adjustable Cable Support



- Provides optimal support for high-performance data cable, up to and including Cat 5e, Cat 6, Cat 6A, Cat 7 and fibre optic
- Simple unlocking and locking of bar allows for additional cables to be added easily after installation
- Adjustable strap allows for multiple support sizes to reduce inventory
- Cost effective alternative to expensive cable tray
- cULus® Listed and complies with NEC® and TIA requirements for structured cabling systems
- Suitable for air handling spaces (plenum)

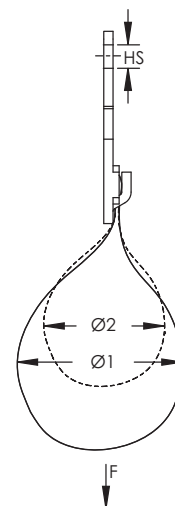

Material: Polyethylene, Steel
Finish: Electro-galvanized



Part Number	Article Number	Area	Cable Capacity, Cat 5e	Cable Capacity, Cat 6	Diameter 1 Ø1	Diameter 2 Ø2	Hole Size HS	Static Load F
CAT425WM	181880	518 mm ²	425	265	150 mm	100 mm	7 mm	450 N

CADDY® CAT 425 ADJUSTABLE CABLE SUPPORTS

CADDY® CAT 425 Adjustable Cable Support with BC Beam Clamp

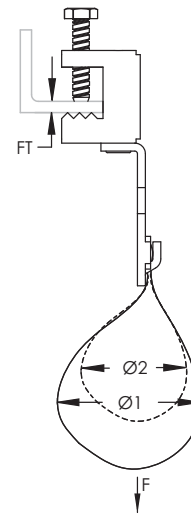

- Easy installation to beam flanges
- Rotates to support various directional runs of cable
- Provides optimal support for high-performance data cable, up to and including Cat 5e, Cat 6, Cat 6A, Cat 7 and fibre optic
- Simple unlocking and locking of bar allows for additional cables to be added easily after installation
- Adjustable strap allows for multiple support sizes to reduce inventory
- Cost effective alternative to expensive cable tray
- cULus® Listed and complies with NEC® and TIA requirements for structured cabling systems
- Suitable for air handling spaces (plenum)

Material: Steel, Spring Steel

Finish: CADDY® ARMOUR, Electro-galvanized



Part Number	Article Number	Area	Cable Capacity, Cat 5e	Cable Capacity, Cat 6	Diameter 1 Ø1	Diameter 2 Ø2	Flange Thickness FT	Static Load F
CAT425EBC	181360	518 mm ²	425	265	150 mm	100 mm	16 mm Max	450 N

CADDY® CAT 425 Adjustable Cable Support with BC200 Beam Clamp

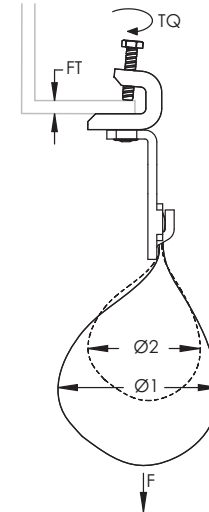

- Easy installation to beam flanges
- Rotates to support various directional runs of cable
- Provides optimal support for high-performance data cable, up to and including Cat 5e, Cat 6, Cat 6A, Cat 7 and fibre optic
- Simple unlocking and locking of bar allows for additional cables to be added easily after installation
- Adjustable strap allows for multiple support sizes to reduce inventory
- Cost effective alternative to expensive cable tray
- cULus® Listed and complies with NEC® and TIA requirements for structured cabling systems
- Suitable for air handling spaces (plenum)

Material: Polyethylene, Steel

Finish: Electro-galvanized



Part Number	Article Number	Area	Cable Capacity, Cat 5e	Cable Capacity, Cat 6	Diameter 1 Ø1	Diameter 2 Ø2	Flange Thickness FT	Torque TQ	Static Load F
CAT425BC200	181460	13,181 mm ²	425	265	150 mm	100 mm	3.2 – 12.7 mm	3 N-m	450 N

CADDY® CAT 425 ADJUSTABLE CABLE SUPPORTS



CADDY® CAT 425 Adjustable Cable Support with Flange Clip



- Requires only a hammer to install
- Provides optimal support for high-performance data cable, up to and including Cat 5e, Cat 6, Cat 6A, Cat 7 and fibre optic
- Simple unlocking and locking of bar allows for additional cables to be added easily after installation
- Adjustable strap allows for multiple support sizes to reduce inventory
- Cost effective alternative to expensive cable tray
- cULus® Listed and complies with NEC® and TIA requirements for structured cabling systems
- Suitable for air handling spaces (plenum)

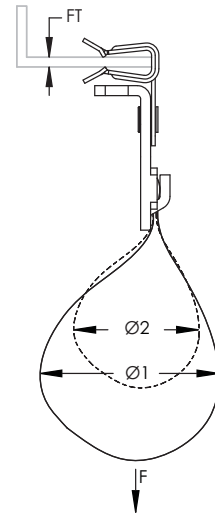

Material: Steel, Spring Steel
Finish: CADDY® ARMOUR, Electro-galvanized



Part Number	Article Number	Area	Cable Capacity, Cat 5e	Cable Capacity, Cat 6	Diameter 1 Ø1	Diameter 2 Ø2	Flange Thickness FT	Static Load F
CAT42524SM	181620	13,181 mm ²	425	265	150 mm	100 mm	3.2 – 6.4 mm	450 N
CAT42558SM	181630	13,181 mm ²	425	265	150 mm	100 mm	7.9 – 12.7 mm	450 N
CAT425912SM	181640	13,181 mm ²	425	265	150 mm	100 mm	14.3 – 19.1 mm	450 N

CADDY® CAT 425 Adjustable Cable Support with C Purlin Clip



- Requires only a hammer to install
- Provides optimal support for high-performance data cable, up to and including Cat 5e, Cat 6, Cat 6A, Cat 7 and fibre optic
- Simple unlocking and locking of bar allows for additional cables to be added easily after installation
- Adjustable strap allows for multiple support sizes to reduce inventory
- Cost effective alternative to expensive cable tray
- cULus® Listed and complies with NEC® and TIA requirements for structured cabling systems
- Suitable for air handling spaces (plenum)

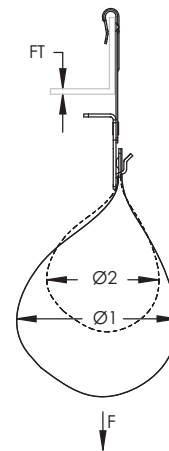

Material: Steel, Spring Steel
Finish: CADDY® ARMOUR, Electro-galvanized



Part Number	Article Number	Area	Cable Capacity, Cat 5e	Cable Capacity, Cat 6	Diameter 1 Ø1	Diameter 2 Ø2	Flange Thickness FT	Static Load F
CAT425VF14	181830	519 mm ²	425	265	150 mm	100 mm	3 – 6 mm	450 N

CADDY® CAT 425 Adjustable Cable Support with Z Purlin Clip

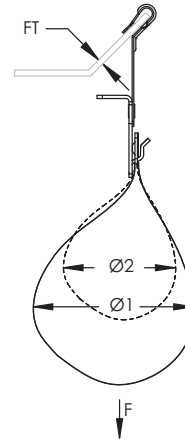

- Requires only a hammer to install
- Provides optimal support for high-performance data cable, up to and including Cat 5e, Cat 6, Cat 6A, Cat 7 and fibre optic
- Simple unlocking and locking of bar allows for additional cables to be added easily after installation
- Adjustable strap allows for multiple support sizes to reduce inventory
- Cost effective alternative to expensive cable tray
- cULus® Listed and complies with NEC® and TIA requirements for structured cabling systems
- Suitable for air handling spaces (plenum)

Material: Steel, Spring Steel
Finish: CADDY® ARMOUR, Electro-galvanized



Part Number	Article Number	Area	Cable Capacity, Cat 5e	Cable Capacity, Cat 6	Diameter 1 Ø1	Diameter 2 Ø2	Flange Thickness FT	Static Load F
CAT425AF14	181870	519 mm²	425	265	150 mm	100 mm	1.6 – 6.0 mm	450 N

CADDY® CAT 425 Adjustable Cable Support with Pedestal Clamp

CADDY® CAT 425 ADJUSTABLE CABLE SUPPORTS

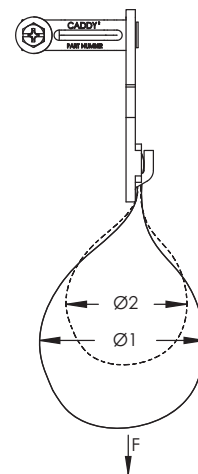

- Easy installation to pedestals used under raised floors
- Provides optimal support for high-performance data cable, up to and including Cat 5e, Cat 6, Cat 6A, Cat 7 and fibre optic
- Simple unlocking and locking of bar allows for additional cables to be added easily after installation
- Adjustable strap allows for multiple support sizes to reduce inventory
- Cost effective alternative to expensive cable tray
- cULus® Listed and complies with NEC® and TIA requirements for structured cabling systems
- Suitable for air handling spaces (plenum)

Material: Polyethylene, Steel
Finish: Electro-galvanized



Part Number	Article Number	Area	Cable Capacity, Cat 5e	Cable Capacity, Cat 6	Diameter 1 Ø1	Diameter 2 Ø2	Pedestal Size	Static Load F
CAT425WMCD1B	181881	13,181 mm²	425	265	150 mm	100 mm	19 mm Square, 22.2 - 28.5 mm Round	220 N



Cable Capacity			CAT 5e	CAT 6	CAT 6A	CAT 7 (SFTP)	Fibre Optic (plenum)
			(5.2 mm 0.21")	(5.9 mm 0.23")	(7.5 mm 0.30")	(7.4 mm 0.29")	(5.1 mm 0.20")
			Bend Radius Requirement*				
			4xØ	4xØ	4xØ	4xØ	10 - 15xØ
Part Number	Area (in ²)	Area (mm ²)	Cable Capacity				
CAT16HP	1.07	690	20	15	10	10	20
CAT21HP	2.29	1,477	50	40	25	25	50
CAT32HP	3.97	2,561	90	60	35	35	90
CAT48HP	9.26	5,974	200	150	80	80	200
CAT64HP	15.48	9,987	330	220	140	140	330
CAT100CM	2 x 1.58	2 x 1,019	70	50	30	30	70
CAT425	20.43	13,181	425	325	210	210	425
CAT200CM	21	13,548	450	350	215	215	450
CAT300CM	32	20,645	700	525	325	325	700
CAT600	3.14	2,026	70	50	30	30	70

* Verify bend radius requirements with cable manufacturer.

Non-continuous supports may not exceed spacing of 5' (1.5 m) per TIA 569-C.9.7.

Cable capacity is calculated based on a 70% fill rate.

ANSI is a registered trademark of American National Standards Institute.

cULus is a registered certification mark of UL LLC.

IEC is a registered service mark of Independent Electrical Contractors, Inc.

ISO is a registered trademark of International Organization for Standardization.

NEC is a registered trademark of, and National Electrical Code (NEC) standard is a copyright of the National Fire Protection Association, Inc.

WARNING

ERICO products shall be installed and used only as indicated in ERICO's product instruction sheets and training materials. Instruction sheets are available at www.erico.com and from your ERICO customer service representative. Improper installation, misuse, misapplication or other failure to completely follow ERICO's instructions and warnings may cause product malfunction, property damage, serious bodily injury and death.

WARRANTY

ERICO products are warranted to be free from defects in material and workmanship at the time of shipment. NO OTHER WARRANTY, WHETHER EXPRESS OR IMPLIED (INCLUDING ANY WARRANTY OF MERCHANTABILITY OR FITNESS FOR A PARTICULAR PURPOSE), SHALL EXIST IN CONNECTION WITH THE SALE OR USE OF ANY ERICO PRODUCTS. Claims for errors, shortages, defects or nonconformities ascertainable upon inspection must be made in writing within 5 days after Buyer's receipt of products. All other claims must be made in writing to ERICO within 6 months from the date of shipment or transport. Products claimed to be nonconforming or defective must, upon ERICO's prior written approval in accordance with its standard terms and procedures governing returns, promptly be returned to ERICO for inspection. Claims not made as provided above and within the applicable time period will be barred. ERICO shall in no event be responsible if the products have not been stored or used in accordance with its specifications and recommended procedures. ERICO will, at its option, either repair or replace nonconforming or defective products for which it is responsible or return the purchase price to the Buyer. THE FOREGOING STATES BUYER'S EXCLUSIVE REMEDY FOR ANY BREACH OF ERICO WARRANTY AND FOR ANY CLAIM, WHETHER SOUNDING IN CONTRACT, TORT OR NEGLIGENCE, FOR LOSS OR INJURY CAUSED BY THE SALE OR USE OF ANY PRODUCT.

LIMITATION OF LIABILITY

ERICO excludes all liability except such liability that is directly attributable to the willful or gross negligence of ERICO's employees. Should ERICO be held liable its liability shall in no event exceed the total purchase price under the contract. ERICO SHALL IN NO EVENT BE RESPONSIBLE FOR ANY LOSS OF BUSINESS OR PROFITS, DOWNTIME OR DELAY, LABOR, REPAIR OR MATERIAL COSTS OR ANY SIMILAR OR DISSIMILAR CONSEQUENTIAL LOSS OR DAMAGE INCURRED BY BUYER.

ERICO®



www.erico.com



AUSTRALIA
Phone 1-800-263-508
Fax 1-800-423-091

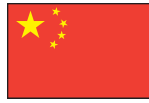

CHINA
Phone +86-21-3430-4878
Fax +86-21-5831-8177



HUNGARY
Phone 06-800-16538
Fax +39-0244-386-107



NORWAY
Phone 800-100-73
Fax 800-100-66



SWITZERLAND
Phone 0800-55-86-97
Fax 0800-55-96-15



BELGIUM
Phone 0800-757-48
Fax 0800-757-60



DENMARK
Phone 808-89-372
Fax 808-89-373



INDONESIA
Phone +62-21-575-0941
Fax +62-21-575-0942



POLAND
Phone +48-71-349-04-60
Fax +48-71-349-04-61



THAILAND
Phone +66-2-267-5776
Fax +66-2-636-6988



BRAZIL
Phone +55-11-3623-4333
Fax +55-11-3621-4066



FRANCE
Phone 0-800-901-793
Fax 0-800-902-024



ITALY
Phone 800-870-938
Fax 800-873-935



SINGAPORE
Phone +65-6-268-3433
Fax +65-6-268-1389



**UNITED ARAB
EMIRATES**
Phone +971-4-881-7250
Fax +971-4-881-7270



CANADA
Phone +1-800-677-9089
Fax +1-800-677-8131



GERMANY
Phone 0-800-189-0272
Fax 0-800-189-0274



MEXICO
Phone +52-55-5260-5991
Fax +52-55-5260-3310



SPAIN
Phone 900-993-154
Fax 900-807-333



UNITED KINGDOM
Phone 0808-2344-670
Fax 0808-2344-676



CHILE
Phone +56-2-370-2908
Fax +56-2-369-5657



HONG KONG
Phone +852-2764-8808
Fax +852-2764-4486



NETHERLANDS
Phone 0800-0200-135
Fax 0800-0200-136



SWEDEN
Phone 020-790-908
Fax 020-798-964



UNITED STATES
Phone 1-800-753-9221
Fax +1-440-248-0723