

CADDY[®]

CADDY[®] SPEED LINK

Universal Support System

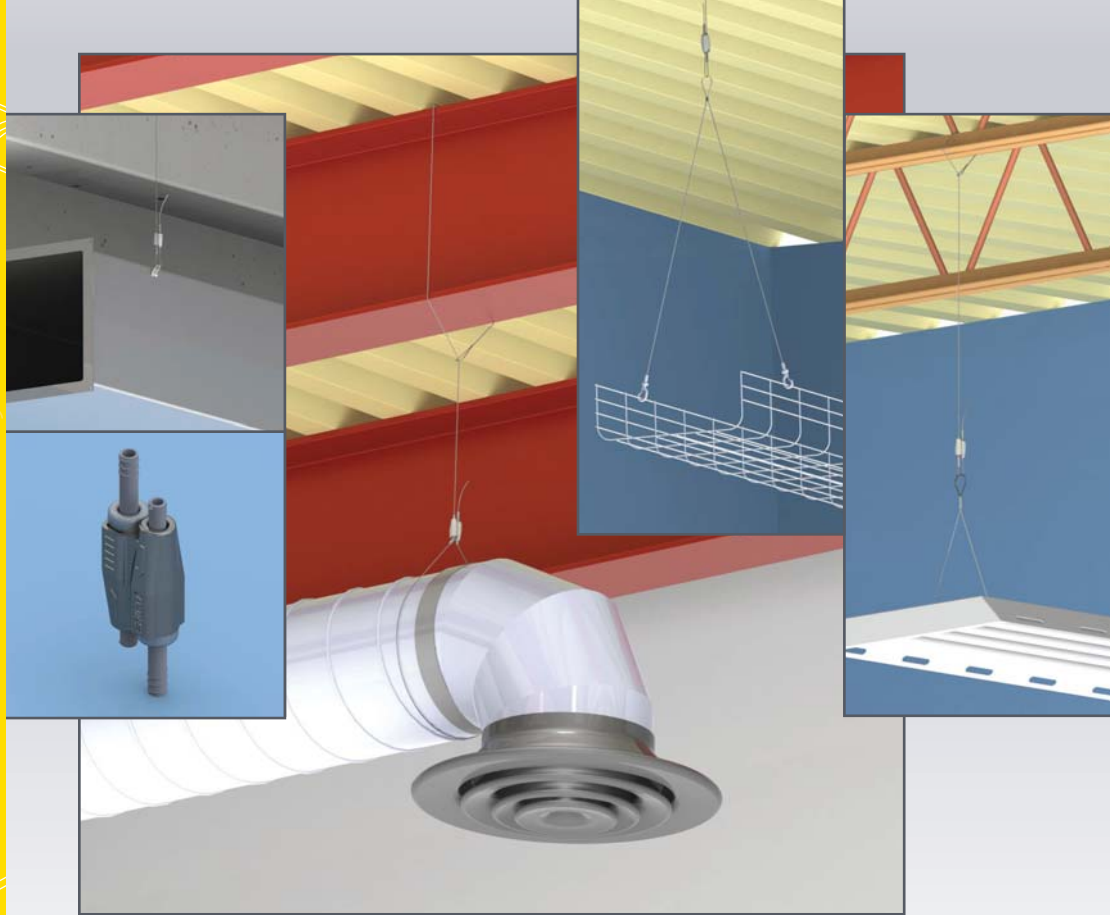
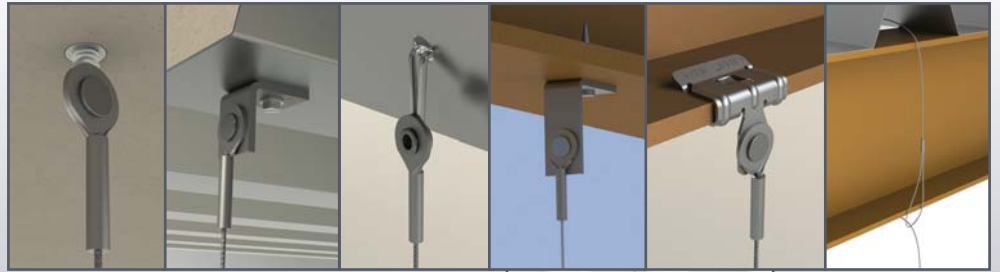

ERICO[®]

HVAC applications

Concrete Structure Attachments



Steel Structure Attachments

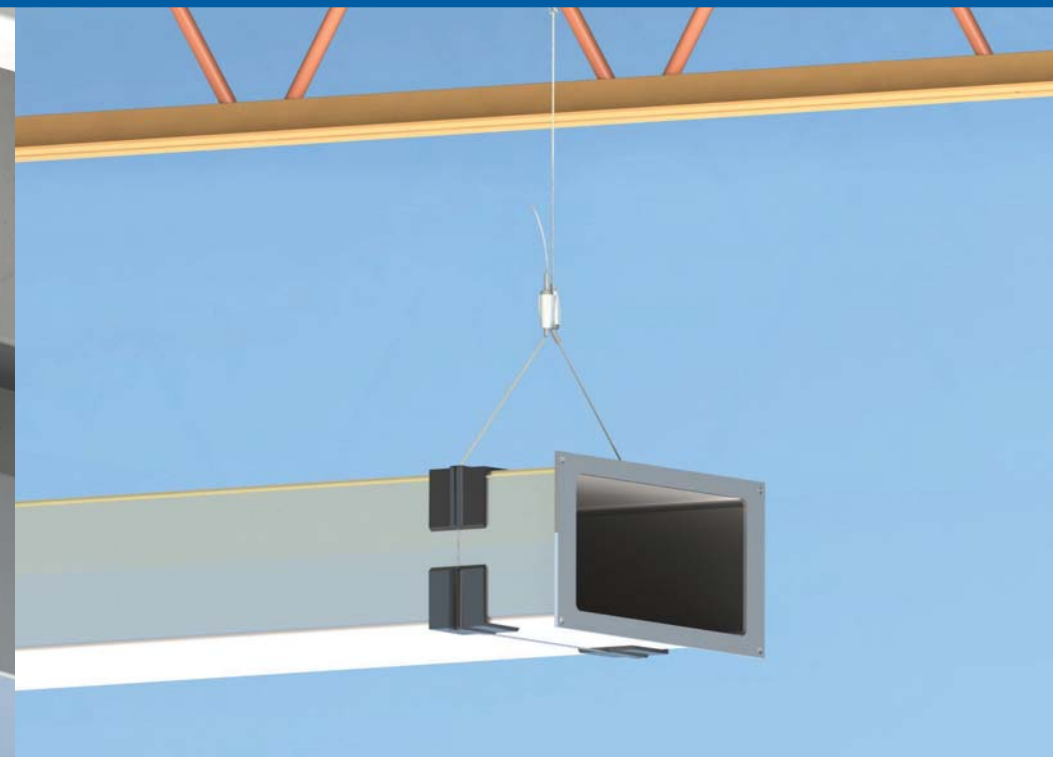
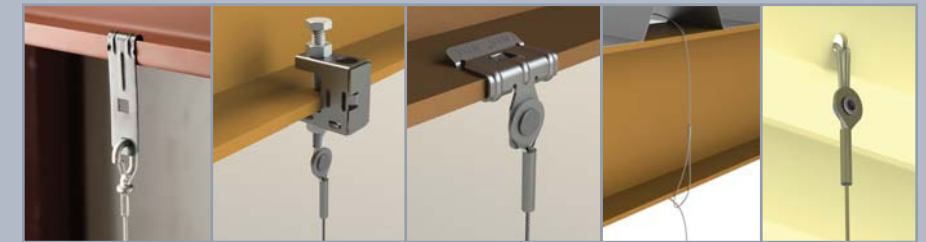

Hanging Solutions

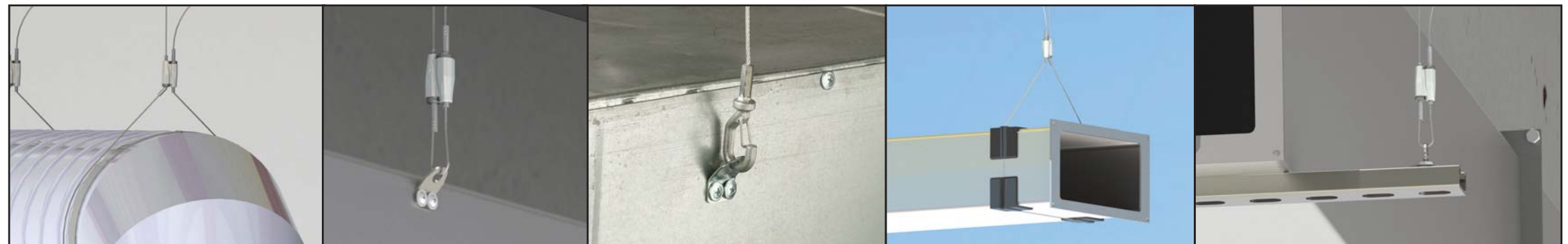

Electrical & Datacom

applications

Concrete Structure Attachments



Steel Structure Attachments

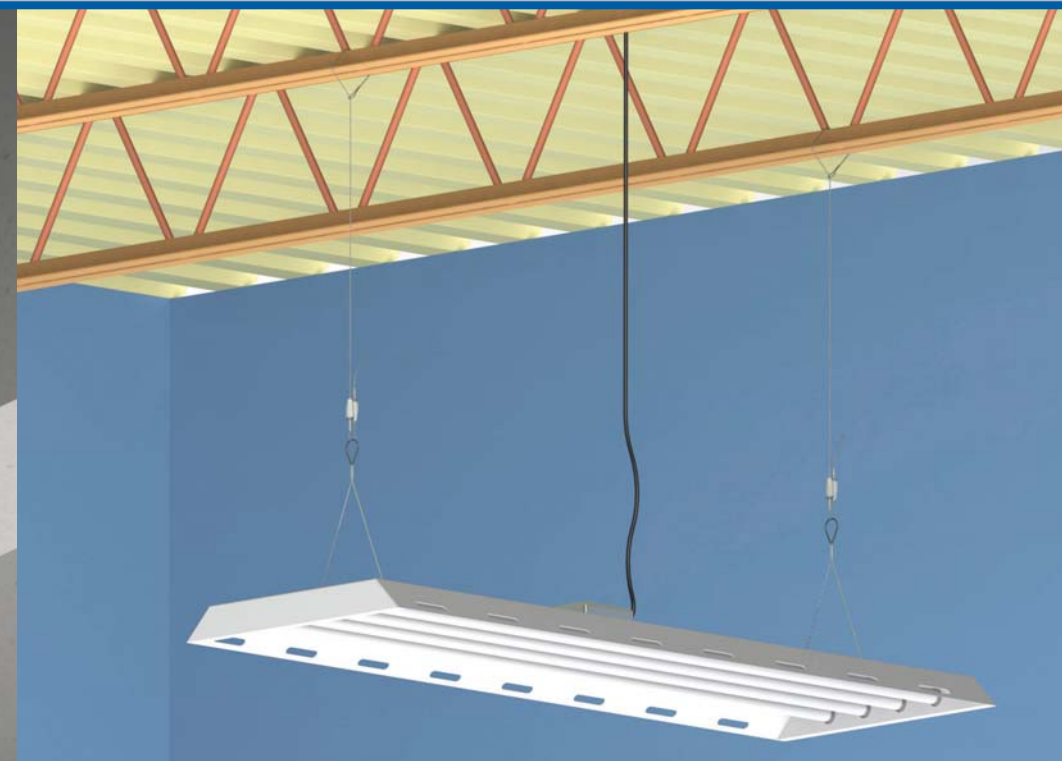
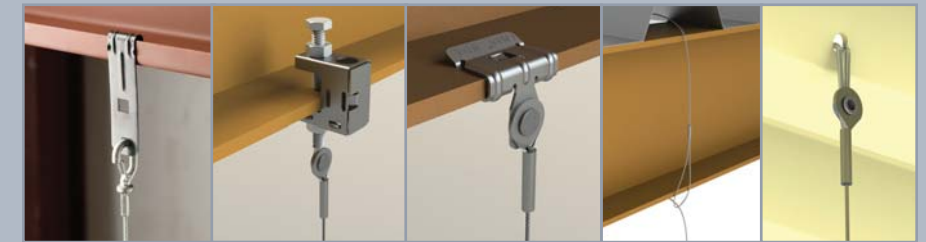

Hanging Solutions

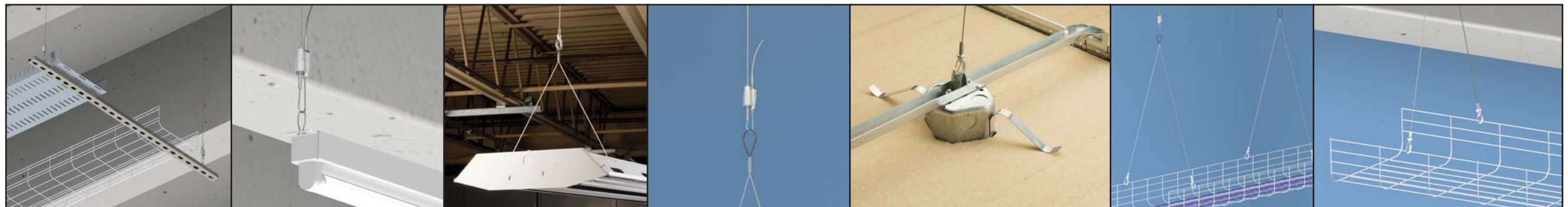

CADDY® SPEED LINK Universal Support System

CADDY® SPEED LINK is a universal support system designed to reduce installation time. A cost-effective alternative to jack chain, threaded rod, strut and strut nuts, this innovative system has the versatility to meet virtually all your support needs.

- Systems include locking device, wire rope, and specialty end fitting
- Strong, yet flexible, wire rope
- Selection of locking devices for different applications and load requirements
- Extensive range of end fittings for various types of structural attachments
- Allows objects to be hung at a variety of angles, even from sloped ceilings
- Works with an assortment of CADDY® fasteners

**CADDY® SPEED LINK
SLK System** | **Pages
7 - 17**

Versatile wire rope system featuring keyless adjustment across a broad range of applications; ideal for hanging ductwork, pipe and tube, cable tray, lighting, conduit, strut profiles and signage.

NEW



**CADDY® SPEED LINK
LD System** | **Page
18**

Light duty wire rope system; ideal for hanging lighting fixtures, ductwork, speakers, alarm sensors, signage and pipes.



**CADDY® SPEED LINK
SD System** | **Page
19**

Heavy duty wire rope system; ideal for hanging cable tray, lighting, ductwork, pipe and tube, conduit, strut profiles and signage from overhead structural building members.



**CADDY® SPEED LINK
SLDM System** | **Page
20**

Light-duty wire rope system with ultra low-profile locking device and threaded stud end. Ideal for supporting electrical boxes, lighting and ductwork.



**CADDY® SPEED LINK
Extensions** | **Pages
21 - 24**

Wire rope extensions with specialty end fittings to combine with other CADDY® SPEED LINK systems.

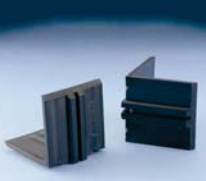

**CADDY® SPEED LINK
Accessories** | **Pages
25 - 30**

Accessories for CADDY® SPEED LINK wire rope systems.



**Related
Products** | **Pages
31 - 34**

Related Products for use with CADDY® SPEED LINK wire rope systems.



CADDY® SPEED LINK SLK System

The CADDY® SPEED LINK SLK system provides a versatile overhead support solution that is easy to adjust and installs quickly to almost any structure. The system supports a wide range of applications, including ductwork, pipe and tube, cable tray, lighting, conduit, strut profiles and signage from overhead structural building members. It is available with a variety of specialty end fittings for the most common building structure types, a range of wire rope diameters and lengths, and includes a unique keyless locking device.

- Push/pull keyless release allows easy adjustments
- System supports both 1.5 mm and 2 mm cables
- Low-profile locking device minimizes visual impact
- Cable spread of 90 degrees allows positioning the device closer to the load
- Keyless release tubes are easy to operate while wearing gloves
- Double-sided locking mechanism enables simple height adjustment
- Individual packaging holds wire rope neatly until objects are ready to install



CADDY® SPEED LINK SLK
with Angle Bracket



CADDY® SPEED LINK SLK
with Shot-Fire Bracket



CADDY® SPEED LINK SLK
with Decking Hook



CADDY® SPEED LINK SLK
with Hammer-On Flange
Clip



CADDY® SPEED LINK SLK
with Hook



CADDY® SPEED LINK SLK
with Loop



CADDY® SPEED LINK SLK
with Threaded Stud End



CADDY® SPEED LINK SLK
with Toggle



CADDY® SPEED LINK SLK
with Y-Hook



CADDY® SPEED LINK SLK
with Y-Toggle

CADDY® SPEED LINK SLK with Angle Bracket

CADDY® SPEED LINK SLK System

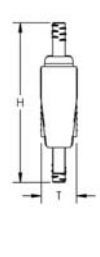
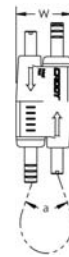
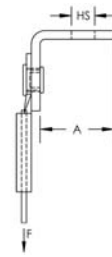

- Complete system includes wire, locking device and pre-assembled angle bracket end fitting
- Ideal for attaching to concrete, steel and using screws to attach to wood surfaces
- Simple alternative to jack chain and additional hardware

Material: Steel, Zinc alloy, Polypropylene
 Finish: Electro-galvanized
 Static Load Safety Factor: 5:1

Part Number	Article Number	Wire Rope Length	A	Hole Size HS	Static Load F
Wire Rope Diameter: 1,5 mm					
SLK15L1AB	196500	1 m	22,6 mm	7,6 mm	195 N
SLK15L2AB	196501	2 m	22,6 mm	7,6 mm	195 N
SLK15L3AB	196502	3 m	22,6 mm	7,6 mm	195 N
SLK15L5AB	196503	5 m	22,6 mm	7,6 mm	195 N
Wire Rope Diameter: 2 mm					
SLK2L2AB	196529	2 m	22,6 mm	7,6 mm	440 N
SLK2L3AB	196530	3 m	22,6 mm	7,6 mm	440 N
SLK2L5AB	196531	5 m	22,6 mm	7,6 mm	440 N

Height H	Width W	Thickness T	Angle a
55 mm	19 mm	12,5 mm	90 ° Max



CADDY® SPEED LINK SLK with Shot-Fire Bracket



- Complete system includes wire, locking device and shot-fire bracket with pre-assembled drive pin from Powers Fasteners, Inc.
- Quickly and easily attaches to concrete, steel or composite metal decking using gas and powder-activated tools
- ICC-ES evaluation report available for drive pin from Powers Fasteners, Inc.

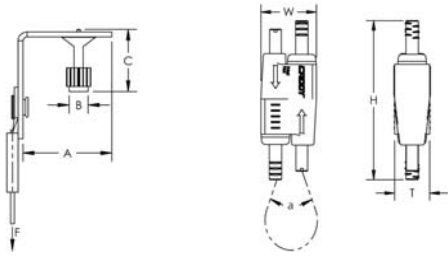

Material: Steel, Zinc alloy, Polypropylene
 Finish: Electro-galvanized
 Static Load Safety Factor: 5:1

Part Number	Article Number	Wire Rope Length	A	B	C	Static Load F
Wire Rope Diameter: 1,5 mm						
SLK15L1SF	196517	1 m	37,5 mm	7,6 mm	31,8 mm	195 N
SLK15L2SF	196518	2 m	37,5 mm	7,6 mm	31,8 mm	195 N
SLK15L3SF	196519	3 m	37,5 mm	7,6 mm	31,8 mm	195 N
SLK15L5SF	196520	5 m	37,5 mm	7,6 mm	31,8 mm	195 N
Wire Rope Diameter: 2 mm						
SLK2L2SF	196546	2 m	37,5 mm	7,6 mm	31,8 mm	440 N
SLK2L3SF	196547	3 m	37,5 mm	7,6 mm	31,8 mm	440 N
SLK2L5SF	196548	5 m	37,5 mm	7,6 mm	31,8 mm	440 N

Height H	Width W	Thickness T	Angle a
55 mm	19 mm	12,5 mm	90 ° Max

Uses Powers Fasteners, Inc. part number 50032. For minimum fastener embedment depths in steel or concrete, please consult www.powers.com.

Pre-assembled drive pin from Powers Fasteners, Inc. works with SPIT® P200, P45, P60; Ramset® TS750P, TS60P; Hilti® DX36M, DX350, DX351, DXA40; Würth Diva-1, BST-1, BST-2 or equivalent nailers.

CADDY® SPEED LINK SLK with Decking Hook

CADDY® SPEED LINK SLK System

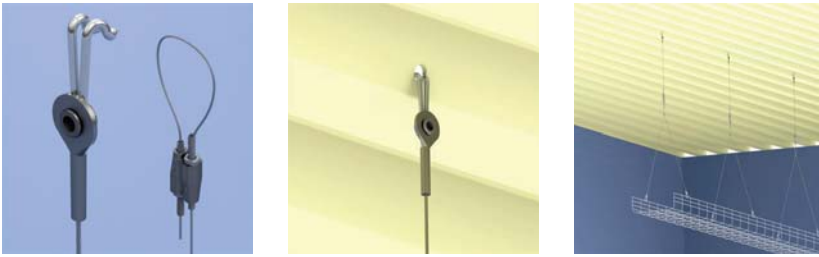

- Complete system includes wire, locking device and pre-assembled decking hook end fitting
- Quickly and easily attaches to hollow metal decking
- Spring-loaded ends snap into decking hole and lock into place
- Innovative design helps protect the wire from sharp edges of decking hole, minimizing risk of damage to wire

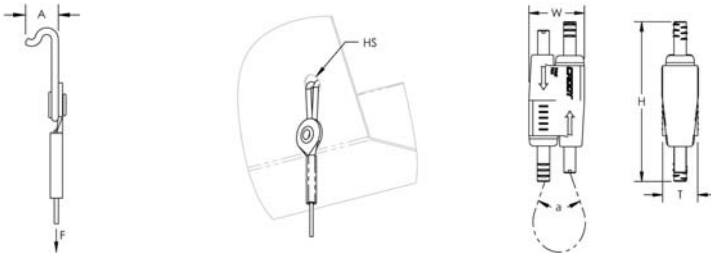

Material: Steel, Zinc alloy, Polypropylene
 Finish: Electro-galvanized
 Static Load Safety Factor: 5:1

Part Number	Article Number	Wire Rope Length	Roof Decking Sheet Thickness	A	Hole Size HS	Static Load F
Wire Rope Diameter: 1,5 mm						
SLK15L3DH	196504	3 m	1,5 mm Max	9,2 mm	8 mm	195 N
SLK15L5DH	196505	5 m	1,5 mm Max	9,2 mm	8 mm	195 N
Wire Rope Diameter: 2 mm						
SLK2L3DH	196532	3 m	1,5 mm Max	9,2 mm	8 mm	440 N
SLK2L5DH	196533	5 m	1,5 mm Max	9,2 mm	8 mm	440 N
SLK2L7DH	196534	7 m	1,5 mm Max	9,2 mm	8 mm	440 N

Height H	Width W	Thickness T	Angle a
55 mm	19 mm	12,5 mm	90 ° Max

Load rating is only applicable if the load-bearing capacity of the supporting element (steel decking) is adequate.
 Check with deck manufacturer for recommended load capacity.



CADDY® SPEED LINK SLK with Hammer-On Flange Clip

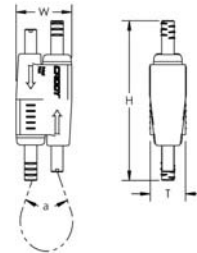
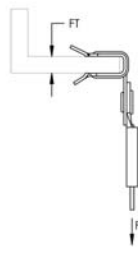
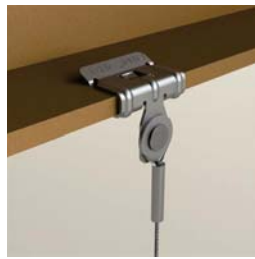

- Complete system includes wire, locking device and pre-assembled CADDY® Hammer-On Flange Clip end fitting
- Installs with just a hammer
- Fits most beams and bulb tees

Material: Steel, Zinc alloy, Polypropylene

Finish: Electro-galvanized

Static Load Safety Factor: 5:1

Part Number	Article Number	Wire Rope Length	Flange Thickness FT	Static Load F
Wire Rope Diameter: 1,5 mm				
SLK15L34H24	196506	3 m	3 – 8 mm	195 N
SLK15L34H58	196507	3 m	8 – 14 mm	195 N
Wire Rope Diameter: 2 mm				
SLK2L34H24	196535	3 m	3 – 8 mm	440 N
SLK2L34H58	196536	3 m	8 – 14 mm	440 N

Height H	Width W	Thickness T	Angle a
55 mm	19 mm	12,5 mm	90 ° Max

CADDY® SPEED LINK SLK with Hook

CADDY® SPEED LINK SLK System



- Complete system includes wire, locking device and pre-assembled hook end fitting
- Hooks to a wide range of CADDY® fasteners
- Fastens to the building structure or hanging services by looping around and hooking to wire rope
- Easy to remove for applications requiring maintenance
- Spring latch helps provide secure connection
- Insert cable through hole and use bottom side of hook as an end stop
- Also available in Y-hook configuration

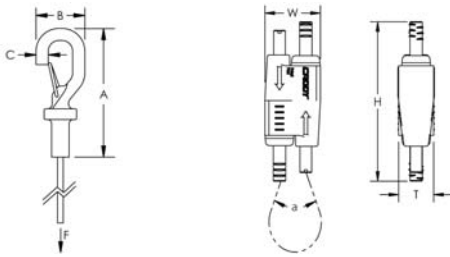

Material: Steel, Polypropylene, Zinc alloy

Finish: Electro-galvanized

Static Load Safety Factor: 5:1

Part Number	Article Number	Wire Rope Length	A	B	C	Static Load F	Standard Packaging Quantity
Wire Rope Diameter: 1,5 mm							
SLK15L1	196508	1 m	58,4 mm	22,9 mm	6,4 mm	195 N	20 pc
SLK15L2	196509	2 m	58,4 mm	22,9 mm	6,4 mm	195 N	20 pc
SLK15L3	196510	3 m	58,4 mm	22,9 mm	6,4 mm	195 N	20 pc
SLK15L5	196511	5 m	58,4 mm	22,9 mm	6,4 mm	195 N	20 pc
SLK15L7	196512	7 m	58,4 mm	22,9 mm	6,4 mm	195 N	20 pc
SLK15L10	196513	10 m	58,4 mm	22,9 mm	6,4 mm	195 N	20 pc
Wire Rope Diameter: 2 mm							
SLK2L1	196537	1 m	58,4 mm	22,9 mm	6,4 mm	440 N	10 pc
SLK2L2	196538	2 m	58,4 mm	22,9 mm	6,4 mm	440 N	10 pc
SLK2L3	196539	3 m	58,4 mm	22,9 mm	6,4 mm	440 N	10 pc
SLK2L5	196540	5 m	58,4 mm	22,9 mm	6,4 mm	440 N	10 pc
SLK2L7	196541	7 m	58,4 mm	22,9 mm	6,4 mm	440 N	10 pc
SLK2L10	196542	10 m	58,4 mm	22,9 mm	6,4 mm	440 N	10 pc

Height H	Width W	Thickness T	Angle a
55 mm	19 mm	12,5 mm	90 ° Max



CADDY® SPEED LINK SLK with Loop



- Complete system includes wire, locking device and pre-assembled loop end fitting
- Easy and flexible solution attaches to building structures
- Wire rope wraps around structure and through loop for quick installation
- Ideal for attaching to purlins, beams and other structural members
- Works well in tight or confined spaces
- Loop attaches directly to pipe, ductwork or other hanging assemblies

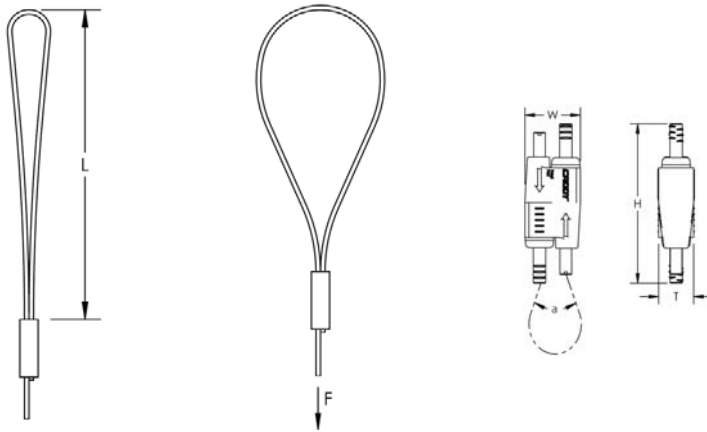

Material: Steel, Polypropylene, Zinc alloy
 Finish: Electro-galvanized
 Static Load Safety Factor: 5:1

Part Number	Article Number	Wire Rope Length	Length L	Static Load F
Wire Rope Diameter: 1,5 mm				
SLK15L1LP	196601	1 m	101 mm	195 N
SLK15L2LP	196514	2 m	101 mm	195 N
SLK15L3LP	196515	3 m	101 mm	195 N
SLK15L5LP	196516	5 m	101 mm	195 N
SLK15L7LP	196602	7 m	101 mm	195 N
SLK15L10LP	196603	10 m	101 mm	195 N
Wire Rope Diameter: 2 mm				
SLK2L1LP	196604	1 m	101 mm	440 N
SLK2L2LP	196543	2 m	101 mm	440 N
SLK2L3LP	196544	3 m	101 mm	440 N
SLK2L5LP	196545	5 m	101 mm	440 N
SLK2L7LP	196605	7 m	101 mm	440 N
SLK2L10LP	196606	10 m	101 mm	440 N

Height H	Width W	Thickness T	Angle a
55 mm	19 mm	12,5 mm	90 ° Max

CADDY® SPEED LINK SLK with Threaded Stud End

CADDY® SPEED LINK SLK System



- Complete system includes wire, locking device and pre-assembled threaded stud end fitting
- Attaches to structures with threaded anchors or devices with threaded hole
- Connects directly to threaded devices in trapeze assemblies, light fixtures, HVAC assemblies or signage

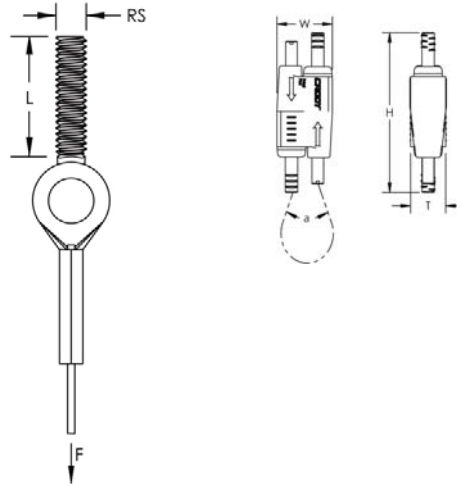

Material: Steel, Polypropylene, Zinc alloy
 Finish: Electro-galvanized
 Static Load Safety Factor: 5:1

Part Number	Article Number	Wire Rope Length	Rod Size RS	Screw Length L	Static Load F
Wire Rope Diameter: 1,5 mm					
SLK15L1SEM6	196564	1 m	M6	25 mm	195 N
SLK15L1SEM8	196565	1 m	M8	25 mm	195 N
SLK15L2SEM6	196566	2 m	M6	25 mm	195 N
SLK15L2SEM8	196567	2 m	M8	25 mm	195 N
SLK15L3SEM6	196568	3 m	M6	25 mm	195 N
SLK15L3SEM8	196570	3 m	M8	25 mm	195 N
Wire Rope Diameter: 2 mm					
SLK2L2SEM6	196558	2 m	M6	25 mm	440 N
SLK2L2SEM8	196559	2 m	M8	25 mm	440 N
SLK2L3SEM6	196560	3 m	M6	25 mm	440 N
SLK2L3SEM8	196561	3 m	M8	25 mm	440 N
SLK2L5SEM6	196562	5 m	M6	25 mm	440 N
SLK2L5SEM8	196563	5 m	M8	25 mm	440 N

Height H	Width W	Thickness T	Angle a
55 mm	19 mm	12,5 mm	90 ° Max



CADDY® SPEED LINK SLK with Toggle

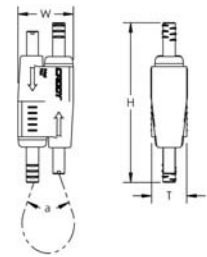

- Complete system includes wire, locking device and pre-assembled toggle end fitting
- Attaches to clearance holes in a variety of structures or hanging devices
- Ideal for supporting lighting fixtures
- Also available in Y-toggle configuration

Material: Steel, Zinc alloy, Polypropylene

Finish: Electro-galvanized

Static Load Safety Factor: 5:1

Wire Rope Diameter: 1,5 mm

Part Number	Article Number	Wire Rope Length	A	B	Static Load F
SLK15L1T	196521	1 m	39 mm	5 mm	195 N
SLK15L2T	196522	2 m	39 mm	5 mm	195 N
SLK15L3T	196523	3 m	39 mm	5 mm	195 N
SLK15L5T	196524	5 m	39 mm	5 mm	195 N
SLK15L7T	196525	7 m	39 mm	5 mm	195 N
SLK15L10T	196526	10 m	39 mm	5 mm	195 N

Height H	Width W	Thickness T	Angle a
55 mm	19 mm	12,5 mm	90 ° Max

CADDY® SPEED LINK SLK with Y-Hook

CADDY® SPEED LINK SLK System

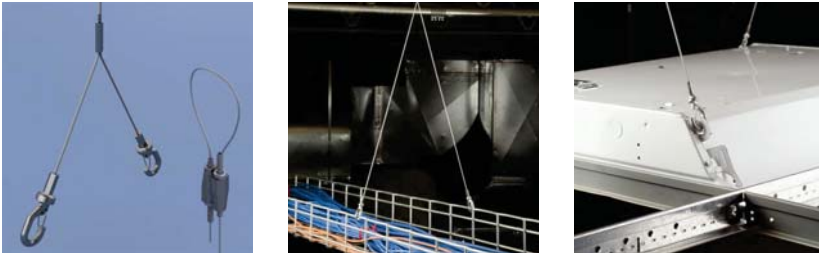

- Complete system includes wire, locking device and two pre-assembled hook end fittings
- Fastens to the building structure and hooks to hanging services and tray
- Spring latch helps provide secure connection
- Convenient design allows one hook to be temporarily detached for maintenance or to add cables to the tray
- Single drop with double hook provides increased stability to the system
- Also available in a single-hook end fitting configuration

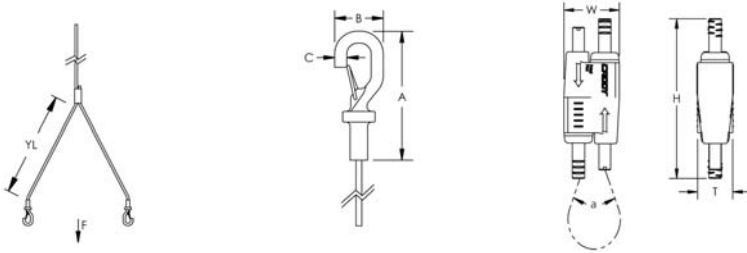

Material: Steel, Zinc alloy, Polypropylene

Finish: Electro-galvanized

Static Load Safety Factor: 5:1

Wire Rope Diameter: 2 mm

Part Number	Article Number	Wire Rope Length	Wire Rope "Y" Length YL	A	B	C	Static Load F
SLK2YH500L2	196549	2 m	500 mm	58,4 mm	22,9 mm	6,4 mm	440 N
SLK2YH500L3	196550	3 m	500 mm	58,4 mm	22,9 mm	6,4 mm	440 N
SLK2YH500L7	196551	7 m	500 mm	58,4 mm	22,9 mm	6,4 mm	440 N

Height H	Width W	Thickness T	Angle a
55 mm	19 mm	12,5 mm	90 ° Max



CADDY® SPEED LINK SLK with Y-Toggle



- Complete system includes wire, locking device and two pre-assembled toggle end fittings
- Attaches to clearance holes in a variety of structures or hanging devices
- Ideal for supporting lighting fixtures

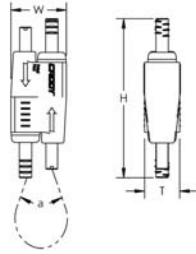
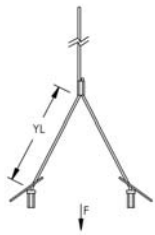

Material: Steel, Zinc alloy, Polypropylene
 Finish: Electro-galvanized
 Static Load Safety Factor: 5:1

Part Number	Article Number	Wire Rope Length	Wire Rope "Y" Length YL	A	B	Static Load F
Wire Rope Diameter: 1,5 mm						
SLK15Y300L3	196527	3 m	300 mm	39 mm	5 mm	195 N
SLK15Y500L3	196528	3 m	500 mm	39 mm	5 mm	195 N
Wire Rope Diameter: 2 mm						
SLK2Y300L2	196552	2 m	300 mm	39 mm	5 mm	440 N
SLK2Y300L3	196553	3 m	300 mm	39 mm	5 mm	440 N
SLK2Y500L3	196554	3 m	500 mm	39 mm	5 mm	440 N
SLK2Y300L5	196555	5 m	300 mm	39 mm	5 mm	440 N
SLK2Y300L7	196556	7 m	300 mm	39 mm	5 mm	440 N
SLK2Y300L10	196557	10 m	300 mm	39 mm	5 mm	440 N

Height H	Width W	Thickness T	Angle a
55 mm	19 mm	12,5 mm	90 ° Max

CADDY® SPEED LINK LD System

The CADDY® SPEED LINK LD system is ideal for hanging light-duty fixtures, ductwork, speakers, alarm sensors, signage and pipes in applications that require all stainless steel components for a greater corrosion resistance.

- Systems include locking device, 1.5 mm diameter wire rope, and specialty end fitting
- Low-profile locking device minimizes visual impact
- Individual packaging holds wire rope neatly until objects are ready to install
- Supported objects are easy to adjust both during and after installation

CADDY® SPEED LINK LD with Hook



- Complete system includes wire, locking device and pre-assembled hook end fitting
- Hooks to a wide range of CADDY® fasteners
- Fastens to the building structure or hanging services by looping around and hooking to wire rope
- Easy to remove for applications requiring maintenance
- Spring latch helps provide secure connection
- Insert cable through hole and use bottom side of hook as an end stop

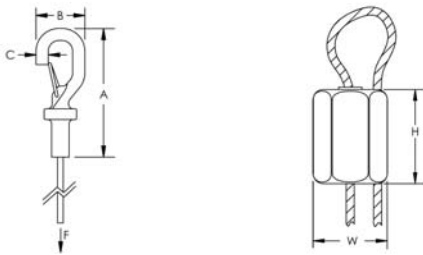

Material: Stainless steel 304
Static Load Safety Factor: 5:1



Part Number	Article Number	Wire Rope Length	Wire Rope Diameter	A	B	C	Static Load F	Standard Packaging Quantity
SLD15L2S	195935	2 m	1,5 mm	58,4 mm	22,9 mm	6,4 mm	195 N	20 x 2 pc
SLD15L5S	195940	5 m	1,5 mm	58,4 mm	22,9 mm	6,4 mm	195 N	20 x 2 pc
SLD15L10S	195945	10 m	1,5 mm	58,4 mm	22,9 mm	6,4 mm	195 N	20 x 2 pc

Height H	Width W
19 mm	12,7 mm



CADDY® SPEED LINK SD System

The CADDY® SPEED LINK SD system supports heavy duty applications, including cable tray, lighting, ductwork, pipe and tube, conduit, strut profiles and signage from overhead structural building members.

- Systems include locking device, 3 mm diameter wire rope, and specialty end fitting
- Individual packaging holds wire rope neatly until objects are ready to install
- Supported objects are easy to adjust both during and after installation

CADDY® SPEED LINK SD with Hook



- Complete system includes wire, locking device and pre-assembled hook end fitting
- Hooks to a wide range of CADDY® fasteners
- Fastens to the building structure or hanging services by looping around and hooking to wire rope
- Easy to remove for applications requiring maintenance
- Spring latch helps provide secure connection
- Insert cable through hole and use bottom side of hook as an end stop

Material: Steel
 Finish: Electro-galvanized
 Static Load Safety Factor: 5:1
 Wire Rope Diameter: 3 mm

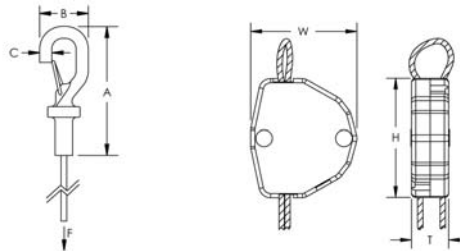

Part Number	Article Number	Wire Rope Length	A	B	C	Static Load F	Standard Packaging Quantity
SLD3L1	195825	1 m	58,4 mm	22,9 mm	6,4 mm	880 N	10 pc
SLD3L1BP	195804	1 m	58,4 mm	22,9 mm	6,4 mm	880 N	1 pc
SLD3L2	195830	2 m	58,4 mm	22,9 mm	6,4 mm	880 N	10 pc
SLD3L2BP	195832	2 m	58,4 mm	22,9 mm	6,4 mm	880 N	1 pc
SLD3L3	195835	3 m	58,4 mm	22,9 mm	6,4 mm	880 N	10 pc
SLD3L3BP	195837	3 m	58,4 mm	22,9 mm	6,4 mm	880 N	1 pc
SLD3L5	195840	5 m	58,4 mm	22,9 mm	6,4 mm	880 N	10 pc
SLD3L5BP	195807	5 m	58,4 mm	22,9 mm	6,4 mm	880 N	1 pc
SLD3L7	196020	7 m	58,4 mm	22,9 mm	6,4 mm	880 N	5 pc
SLD3L10	195845	10 m	58,4 mm	22,9 mm	6,4 mm	880 N	5 pc
SLD3L10BP	195808	10 m	58,4 mm	22,9 mm	6,4 mm	880 N	1 pc

Height H	Width W	Thickness T
36,8 mm	32,3 mm	12,7 mm

CADDY® SPEED LINK SD System

CADDY® SPEED LINK SLDM System

The CADDY® SPEED LINK SLDM system is a light-duty rope system with an ultra-low-profile locking device and threaded stud. The system is ideal for supporting electrical boxes, lighting and signage.

- Systems include locking device, 1.5 mm diameter wire rope, and specialty end fitting
- Sleek, low-profile locking device reduces visual impact
- Individual packaging holds wire rope neatly until objects are ready to install
- Supported objects are easy to adjust both during and after installation

CADDY® SPEED LINK SLDM with Hook

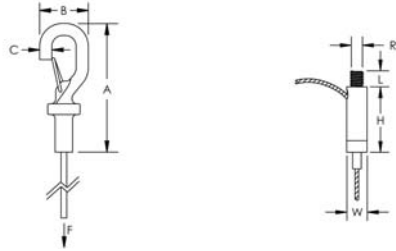
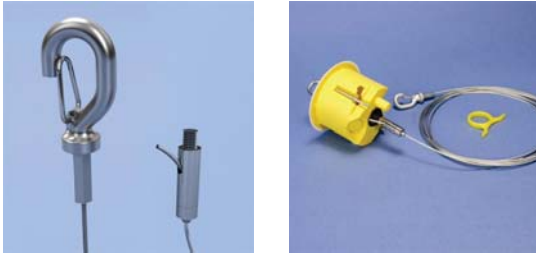

- Complete system includes wire, locking device and pre-assembled hook end fitting
- Ideal for supporting lighting, ductwork and other installation projects
- Sleek, low-profile locking device reduces visual impact
- Keyless locking device is adjustable even after installation

Material: Steel

Finish: Electro-galvanized

Static Load Safety Factor: 5:1

Part Number	Article Number	Wire Rope Diameter	Wire Rope Length	A	B	C	Static Load F
SLDM615L1	196028	1,5 mm	1 m	58,4 mm	22,9 mm	6,4 mm	195 N
SLDM615L2	196029	1,5 mm	2 m	58,4 mm	22,9 mm	6,4 mm	195 N
SLDM615L3	196030	1,5 mm	3 m	58,4 mm	22,9 mm	6,4 mm	195 N

Rod Size RS	Length L	Height H	Width W
M6	7 mm	24,5 mm	9,2 mm



CADDY® SPEED LINK Extensions

CADDY® SPEED LINK extensions allow standard CADDY® SPEED LINK Systems to be lengthened for long drop applications, putting the height adjustment closer to the object being supported. These short sections of wire include speciality end fittings at one end and a small loop or hook at the other. The extensions combine perfectly with other CADDY® SPEED LINK Systems, and can also be used separately as a backup wire.

- Ideal for use with standard CADDY® SPEED LINK Systems
- A range of end fittings easily adapt to various jobs
- Wire rope is securely looped and crimped
- Ideal as a support or secondary wire



CADDY® SPEED LINK
Y-Hook with
Eyelet Extension

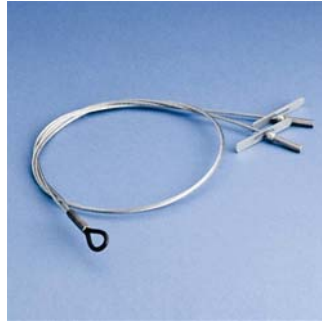

CADDY® SPEED LINK
Y-Toggle with
Eyelet Extension



CADDY® SPEED LINK
Y-Toggle with
Hook Extension



CADDY® SPEED LINK
Quad-Toggle with
Eyelet Extension

CADDY® SPEED LINK Y-Hook with Eyelet Extension

CADDY® SPEED LINK Extensins



- Double hook offers easy attachment to basket tray, cable tray or lighting
- Convenient design allows one hook to be temporarily detached for maintenance or to add cables to the tray
- Y-design provides improved stability
- Spring latch helps provide secure connection

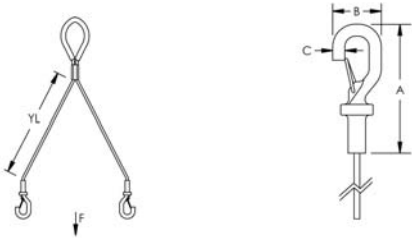

Material: Steel
 Finish: Electro-galvanized
 Static Load Safety Factor: 5:1



Part Number	Article Number	Wire Rope "Y" Length YL	A	B	C	Static Load F
Wire Rope Diameter: 2 mm						
SLD2YH500	196015	500 mm	58,4 mm	22,9 mm	6 mm	440 N
SLD2YH800	196016	800 mm	58,4 mm	22,9 mm	6 mm	440 N
Wire Rope Diameter: 3 mm						
SLD3YH500	196017	500 mm	58,4 mm	22,9 mm	6 mm	880 N
SLD3YH800	195998	800 mm	58,4 mm	22,9 mm	6 mm	880 N

CADDY® SPEED LINK locking device not included.



CADDY® SPEED LINK Y-Toggle with Eyelet Extension

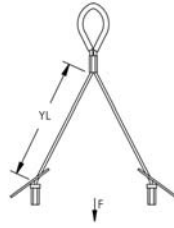

- Attaches to clearance holes in a variety of structures or hanging devices
- Ideal for supporting lighting fixtures
- Y-design provides improved stability

Material: Steel

Finish: Electro-galvanized

Static Load Safety Factor: 5:1



Part Number	Article Number	Wire Rope "Y" Length YL	A	B	Static Load F	Standard Packaging Quantity
Wire Rope Diameter: 1,5 mm						
SLD15Y200	195999	200 mm	42 mm	8 mm	195 N	20 pc
SLD15Y300	196000	300 mm	42 mm	8 mm	195 N	20 pc
SLD15Y500	195960	500 mm	42 mm	8 mm	195 N	20 pc
SLD15Y500TP	195996	500 mm	42 mm	8 mm	195 N	20 x 2 pc
SLD15Y800	195965	800 mm	42 mm	8 mm	195 N	20 pc
SLD15Y800TP	195997	800 mm	42 mm	8 mm	195 N	20 x 2 pc
Wire Rope Diameter: 2 mm						
SLD2Y300	196036	300 mm	42 mm	8 mm	440 N	20 pc
SLD2Y500	176870	500 mm	42 mm	8 mm	440 N	20 pc

CADDY® SPEED LINK locking device not included.

CADDY® SPEED LINK Y-Toggle with Hook Extension

CADDY® SPEED LINK Extensions



- Attaches to clearance holes in a variety of structures or hanging devices
- Ideal for supporting lighting fixtures
- Y-design provides improved stability
- Spring latch of hook helps provide secure connection
- Hooks to a wide range of CADDY® fasteners

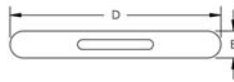
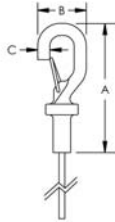

Material: Steel
 Finish: Electro-galvanized
 Static Load Safety Factor: 5:1



Part Number	Article Number	Wire Rope Diameter	Wire Rope "Y" Length YL	Wire Rope Length	A	B	C	D	E	Static Load F
SLD2Y300L050H	196042	2 mm	300 mm	50 mm	58,4 mm	22,9 mm	6,4 mm	42 mm	8 mm	440 N

CADDY® SPEED LINK locking device not included.

CADDY® SPEED LINK Y-Toggle with Eyelet Extension



- Secure hanging solution for use on control access points, projectors, etc.

Material: Steel
 Finish: Electro-galvanized
 Static Load Safety Factor: 5:1



Part Number	Article Number	Wire Rope Diameter	Wire Rope "Y" Length YL	A	B	Static Load F
SLD15QT250	196007	1,5 mm	250 mm	42 mm	8 mm	195 N

CADDY® SPEED LINK locking device not included.



CADDY® SPEED LINK Accessories

CADDY® SPEED LINK accessories are specially designed to work with CADDY SPEED LINK systems. Locking devices and bulk wire are available for highly customized applications. Other accessories complement the CADDY SPEED LINK portfolio to simplify installation.



CADDY® SPEED LINK SLK
Locking Device



CADDY® SPEED LINK LD
Locking Device



CADDY® SPEED LINK SD
Locking Device



Wire Spool



Wire Rope Cutter

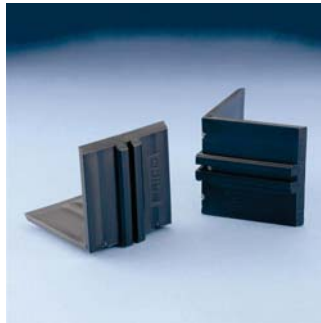

Air Duct Corner Protector



Air Duct Support
Attachment



Concrete Fixing
Eyebolt Screw



Eye Screw



Light Duty Light
Fixture Eyelet



Medium Duty Light
Fixture Eyelet



MC/AC Cable Clip

CADDY® SPEED LINK Accessories

CADDY® SPEED LINK SLK Locking Device

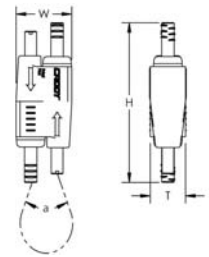
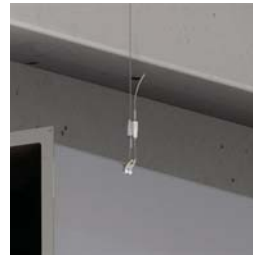
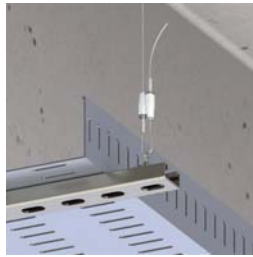

- Push/pull keyless release allows easy adjustments
- Suitable for 1.5 mm and 2 mm CADDY® SPEED LINK cable
- Low-profile locking device minimizes visual impact
- Cable spread of 90 degrees allows positioning the device closer to the load
- Keyless release tubes are easy to operate while wearing gloves
- Double-sided locking mechanism enables simple height adjustment

Material: Steel, Polypropylene, Zinc alloy

Part Number	Article Number	Wire Rope Diameter	Height H	Width W	Thickness T	Angle a
SLK2C200	196600	1,5 – 2 mm	55 mm	19 mm	12,5 mm	90 ° Max

Locking device is only to be used with SLC15L50MSP, SLC15L1000SP and SLC2L1000SP wire spools or 1.5 mm and 2 mm CADDY® SPEED LINK accessories. Do not use with any other wires.

CADDY® SPEED LINK Accessories

CADDY® SPEED LINK LD Locking Device

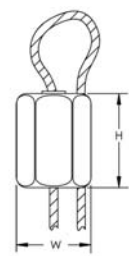
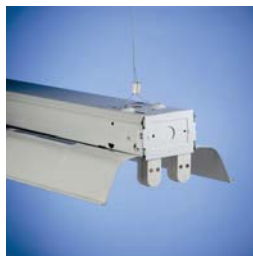

- Low-profile locking device minimizes visual impact
- Suitable for 1.5 mm CADDY® SPEED LINK cable

Material: Stainless steel 304

Part Number	Article Number	Wire Rope Diameter	Height H	Width W
SLJR200	196008	1,5 mm	19 mm	12,7 mm

The 1.5 mm locking devices are only to be used with the SLC15L1000SP and SLC15L50MSP wire spools, or any other 1.5 mm CADDY® SPEED LINK accessories. Do not use with any other wires.



CADDY® SPEED LINK SD Locking Device

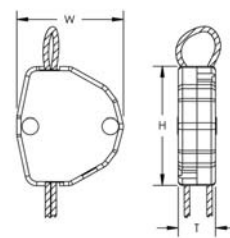

- Suitable for 2 mm and 3 mm CADDY® SPEED LINK cable

Material: Steel

Finish: Electro-galvanized

Part Number	Article Number	Wire Rope Diameter	Height H	Width W	Thickness T
QLD200	196009	2 – 3 mm	36,8 mm	32,3 mm	12,7 mm

The 2 mm and 3 mm devices are only to be used with the SLC2L1000SP and SLC3L1000SP wire spools or 2 mm and 3 mm CADDY® SPEED LINK accessories. Do not use with any other wires.

Wire Spool



- Spool with CADDY® SPEED LINK steel wire
- Wire rope constructed from seven bundles of seven strands each of steel aircraft wire

Material: Steel

Finish: Electro-galvanized

Part Number	Article Number	Wire Rope Diameter	Length	Static Load
SLC15L50MSP	196023	1,5 mm	50 m	195 N
SLC15L1000SP	196001	1,5 mm	300 m	195 N
SLC2L1000SP	196002	2 mm	300 m	440 N
SLC3L1000SP	196003	3 mm	300 m	880 N

Wire Rope Cutter



- Designed to reduce wire rope fraying

Material: Steel

Part Number	Article Number
SLWC	195853

Air Duct Corner Protector

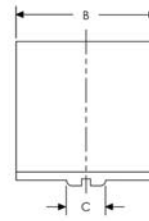
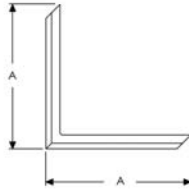
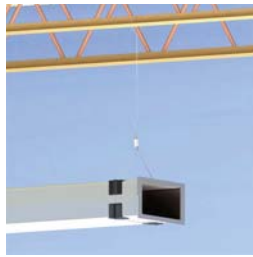
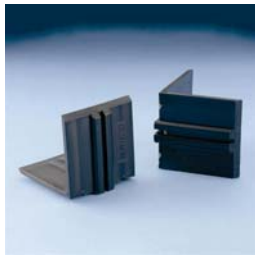

- Includes rib to keep the wire rope in place
- Prevents the wire rope from damaging the duct

Material: Polyvinylchloride
Color: Black

Part Number	Article Number	A	B	C
SLADCP	195851	52 mm	50 mm	14 mm

CADDY® SPEED LINK Accessories

Air Duct Support Attachment

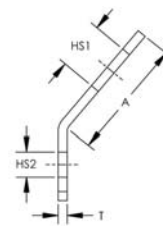

- Angled bracket for installation on to round or square duct
- Designed to accept CADDY® SPEED LINK wire rope or hook

Material: Steel
Finish: Electro-galvanized

Part Number	Article Number	Hole Size 1 HS1	Hole Size 2 HS2	A	B	Thickness T
SLADS	195852	8 mm	4,2 mm	20 mm	10 mm	1,5 mm



Concrete Fixing Eyebolt Screw

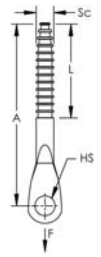

- For use in concrete and brick
- Includes drill bit adaptor for easy installation

Material: Steel

Finish: Electro-galvanized

Part Number	Article Number	Hole Size HS	Screw Diameter Sc	Screw Length L	A	Drill Bit Size	Static Load F
CFEB05	195864	6,5 mm	H6	45 mm	60 mm	5 mm	700 N

Eye Screw

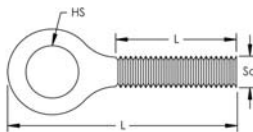

Material: Steel

Finish: Electro-galvanized

Part Number	Article Number	Screw Diameter Sc	Screw Length L	Hole Size HS	Length L
SLEBM6	195854	M6	20 mm	7,2 mm	37,5 mm
SLEBM8	195856	M8	25 mm	8,5 mm	50 mm
SLEBWS	195858	H6	32 mm	8,8 mm	60 mm

MC/AC Cable Clip



- Spring steel cable attachment
- Allows for electrical cable to be attached to CADDY® SPEED LINK wire rope

Material: Steel

Finish: CADDY® ARMOUR

Part Number	Article Number	Outer Diameter
SL1214	195860	11,8 – 14,2 mm
SL1518	195861	12,7 – 18,2 mm

Light Duty Light Fixture Eyelet



- Inserts into openings of light fixture
- Hook or loop through lighting clip to suspend lighting from wire rope or chain

Material: Stainless steel 302

Part Number	Article Number	Diameter Ø	A	Static Load F
SLLC250	195863	8 mm	1,5 mm	55 N

Do not use light fixture eyelet as a lifting device.

CADDY® SPEED LINK Accessories

Medium Duty Light Fixture Eyelet

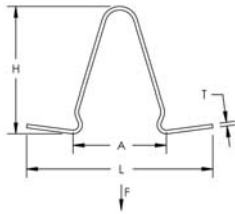

- Inserts into openings of light fixture
- Hook or loop through lighting clip to suspend lighting from wire rope or chain

Material: Steel

Finish: Electro-galvanized

Part Number	Article Number	Height H	Length L	Width W	Thickness T	A	Static Load F
DFF1	172930	35 mm	51 mm	8 mm	1 mm	16,5 mm	125 N

Do not use light fixture eyelet as a lifting device.



Related Products

These related products complement CADDY® SPEED LINK installations and offer solutions to difficult overhead support challenges. Visit www.erico.com for the full range of CADDY Fixings, Fasteners, and Supports.



VF Series C Purlin Clip



Independent Support Clip



BC Beam Clamp



300M Universal Beam Clamp

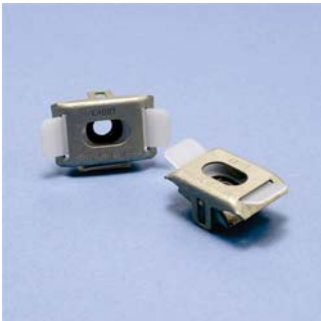

CADDY® SLICK NUT

VF Series C Purlin Clip

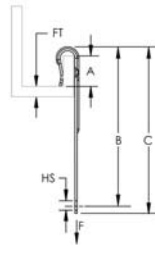

- Supports wire or rod from bar joist and purlin
- Installs from floor with VAFT tool and conduit

Material: Steel

Finish: CADDY® ARMOUR



Part Number	Article Number	Flange Thickness FT	A	B	C	Hole Size HS	Static Load F	Standard Packaging Quantity
VF14	179850	1,5 – 6 mm	20 mm Min	80 mm	90 mm	7,1 mm	600 N	100 pc

Independent Support Clip

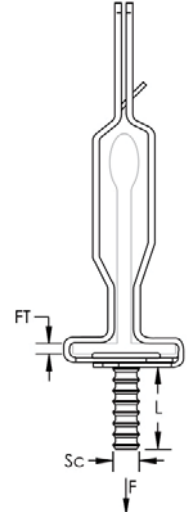

- Provides a means of independent support of fixtures
- No tools required for installation
- Includes mounting hardware

Material: Steel

Finish: CADDY® ARMOUR

Part Number	Article Number	T-Grid Size	Flange Thickness FT	Screw Diameter Sc	Screw Length L	Static Load F	Included Components
IDS9	173460	24 mm	1,5 mm	M6	16 mm	290 N	-

IDS9 for use with Ultra Line 3500, AWW Ultra Line 3600 (a trademark product of Chicago Metallics Corp.)

Related Products



BC Beam Clamp

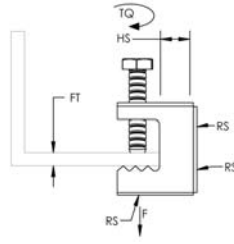

- Easy installation to beam flanges

Material: Steel
Finish: CADDY® ARMOUR

Part Number	Article Number	Rod Size RS	Hole Size HS	Flange Thickness FT	Torque TQ	Static Load F	Standard Packaging Quantity
EBC	170380	M6	10,5 mm	16 mm Max	3 N-m	450 N	100 pc
EBCSP25	172430	M6	10,5 mm	16 mm Max	3 N-m	450 N	10 x 25 pc

Setscrew must be tightened and torqued onto the sloped side of the I-beam.

300M Universal Beam Clamp

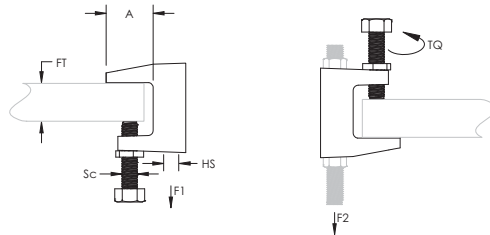

Material: Cast iron
Finish: Electro-galvanized



Part Number	Article Number	Hole Size HS	Hole Type	Flange Thickness FT	A	Screw Diameter Sc	Torque TQ	Static Load 1 F1	Static Load 2 F2	Approvals
300M6	386805	M6	Threaded	20.6 mm Max	21 mm	M8	14 N-m	1,200 N	1,200 N	-
300M6SP5	175910	M6	Threaded	20.6 mm Max	21 mm	M8	14 N-m	1,200 N	1,200 N	-
300M8	386810	M8	Threaded	20.6 mm Max	21 mm	M8	14 N-m	1,200 N	1,200 N	VdS

Setscrew must be tightened and torqued onto the sloped side of the I-beam.

Related Products

CADDY® SLICK NUT



- Provides fast universal attachment of threaded rod and hardware to standard strut profiles

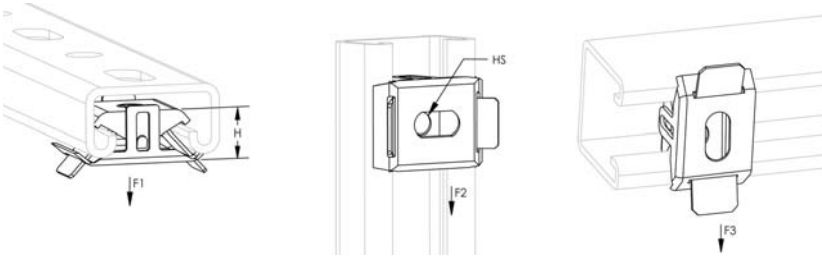

Material: Steel, Polyamide
Finish: CADDY® ARMOUR

Part Number	Article Number	Hole Size HS	Hole Type	Height H	Torque TQ	Static Load 1 F1	Static Load 2 F2	Static Load 3 F3
SLICKM6	174460	M6	Threaded	17 mm	5,4 N-m	1.800 N	450 N	1.100 N
SLICKM8	174340	M8	Threaded	17 mm	8,1 N-m	2.700 N	450 N	1.100 N
SLICKM10	174350	M10	Threaded	17 mm	13,6 N-m	2.700 N	450 N	1.100 N
SLICKM12	174550	M12	Threaded	17 mm	13,6 N-m	2.700 N	450 N	1.100 N

Indicated loads are independent of the threaded stud or rod.

Indicated loads are applicable on 14 GA and 12 GA (2 mm and 2.5 mm) strut channels only.

Related Products



cULus is a registered certification mark of UL LLC.

HILTI is a registered trademark of Hilti Aktiengesellschaft.

Ramset is a registered trademark of Illinois Tool Works, Inc.

SPIT is a registered trademark of Societe De Prospection & D'Inventions Techniques Spit.

VdS is a registered trademark of VdS Schadenverhütung GmbH.

WARNING

ERICO products shall be installed and used only as indicated in ERICO's product instruction sheets and training materials. Instruction sheets are available at www.erico.com and from your ERICO customer service representative. Improper installation, misuse, misapplication or other failure to completely follow ERICO's instructions and warnings may cause product malfunction, property damage, serious bodily injury and death.

WARRANTY

ERICO products are warranted to be free from defects in material and workmanship at the time of shipment. NO OTHER WARRANTY, WHETHER EXPRESS OR IMPLIED (INCLUDING ANY WARRANTY OF MERCHANTABILITY OR FITNESS FOR A PARTICULAR PURPOSE), SHALL EXIST IN CONNECTION WITH THE SALE OR USE OF ANY ERICO PRODUCTS. Claims for errors, shortages, defects or nonconformities ascertainable upon inspection must be made in writing within 5 days after Buyer's receipt of products. All other claims must be made in writing to ERICO within 6 months from the date of shipment or transport. Products claimed to be nonconforming or defective must, upon ERICO's prior written approval in accordance with its standard terms and procedures governing returns, promptly be returned to ERICO for inspection. Claims not made as provided above and within the applicable time period will be barred. ERICO shall in no event be responsible if the products have not been stored or used in accordance with its specifications and recommended procedures. ERICO will, at its option, either repair or replace nonconforming or defective products for which it is responsible or return the purchase price to the Buyer. THE FOREGOING STATES BUYER'S EXCLUSIVE REMEDY FOR ANY BREACH OF ERICO WARRANTY AND FOR ANY CLAIM, WHETHER SOUNDING IN CONTRACT, TORT OR NEGLIGENCE, FOR LOSS OR INJURY CAUSED BY THE SALE OR USE OF ANY PRODUCT.

LIMITATION OF LIABILITY

ERICO excludes all liability except such liability that is directly attributable to the willful or gross negligence of ERICO's employees. Should ERICO be held liable its liability shall in no event exceed the total purchase price under the contract. ERICO SHALL IN NO EVENT BE RESPONSIBLE FOR ANY LOSS OF BUSINESS OR PROFITS, DOWNTIME OR DELAY, LABOR, REPAIR OR MATERIAL COSTS OR ANY SIMILAR OR DISSIMILAR CONSEQUENTIAL LOSS OR DAMAGE INCURRED BY BUYER.

ERICO®



www.erico.com



AUSTRALIA
Phone 1-800-263-508
Fax 1-800-423-091

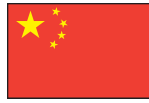

CHINA
Phone +86-21-3430-4878
Fax +86-21-5831-8177



HUNGARY
Phone 06-800-16538
Fax +39-0244-386-107



NORWAY
Phone 800-100-73
Fax 800-100-66



SWITZERLAND
Phone 0800-55-86-97
Fax 0800-55-96-15



BELGIUM
Phone 0800-757-48
Fax 0800-757-60



DENMARK
Phone 808-89-372
Fax 808-89-373



INDONESIA
Phone +62-21-575-0941
Fax +62-21-575-0942



POLAND
Phone +48-71-349-04-60
Fax +48-71-349-04-61



THAILAND
Phone +66-2-267-5776
Fax +66-2-636-6988



BRAZIL
Phone +55-11-3623-4333
Fax +55-11-3621-4066



FRANCE
Phone 0-800-901-793
Fax 0-800-902-024



ITALY
Phone 800-870-938
Fax 800-873-935



SINGAPORE
Phone +65-6-268-3433
Fax +65-6-268-1389



**UNITED ARAB
EMIRATES**
Phone +971-4-881-7250
Fax +971-4-881-7270



CANADA
Phone +1-800-677-9089
Fax +1-800-677-8131



GERMANY
Phone 0-800-189-0272
Fax 0-800-189-0274



MEXICO
Phone +52-55-5260-5991
Fax +52-55-5260-3310



SPAIN
Phone 900-993-154
Fax 900-807-333



UNITED KINGDOM
Phone 0808-2344-670
Fax 0808-2344-676



CHILE
Phone +56-2-370-2908
Fax +56-2-369-5657



HONG KONG
Phone +852-2764-8808
Fax +852-2764-4486



NETHERLANDS
Phone 0800-0200-135
Fax 0800-0200-136



SWEDEN
Phone 020-790-908
Fax 020-798-964



UNITED STATES
Phone 1-800-753-9221
Fax +1-440-248-0723